

Workwear and professional footwear

Comfort and ESD safety
in the workplace



Welcome at DPV

For more than 30 years we have been a system partner for the electronics and automotive industries. Our customers around the world rely on our ESD-compliant solutions and customized services.

Our team of experts is will be happy to advise you on all questions on all aspects of ESD.



DPV Elektronik-Service GmbH
Herregrundstr. 1
75031 Eppingen
Germany



Team North
Postcode areas 0 to 5
+49 (0)7262 9163-182
TeamNord@dpv-elektronik.de

Team South
Postcode areas 6 to 9
+49 (0)7262 9163-185
TeamSued@dpv-elektronik.de

Phone: +49 (0)7262 9163-0
Fax: +49 (0)7262 9163-90
sales@dpv-elektronik.de
www.dpv-elektronik.de



Europe / International
+49 (0)7262 9163-200
export@dpv-elektronik.de



Compumet AG
+41 (0)61 836 10 50
info@compumet.ch

**CUSTOMER SERVICE
AND QUALITY ASSURANCE**

+49 (0)7262 9163-500
service@dpv-elektronik.de

Quality management according to ISO 9001

An efficient quality management system certified according to ISO 9001:2015 ensures the compliance of our high quality level.



We are at your service

Quickly found and easily ordered

Everything at a glance with the catalog

You want to get an idea of our product range or are looking for a special article or product group? The lists in this catalog will help you get along.

Our EPA brands	page	6
ESD protected area	page	8
Content	page	11
Index	page	162
Technical information	page	164



Find the product quickly with dpvlink and QR code

You have found the desired product in the catalog and would like to look at or order it online? Go to www.dpv-elektronik.de and simply enter the number of the green dpvlink or the article number in the search field. This will help you to find quickly and easily all further product information.

Being informed on the go at any time

Do you want to get product information while you are out and about? Scan the QR code in the catalog with your mobile phone, tablet or scanner and share or save the information available to hand at any time.

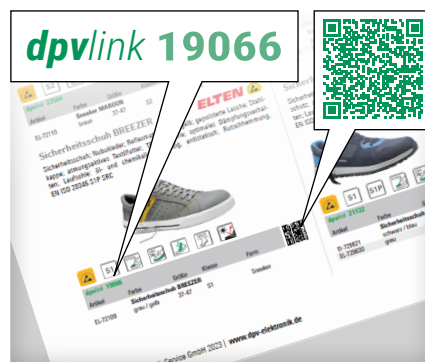

Your advantage as a registered customer

If you are not yet a registered customer and have any questions, simply phone us or sign up as a business customer directly online.

- **Your prices**
After logging in you see your personal prices immediately, at any time and up-to-date.
- **All product information**
You can download technical datasheets, safety datasheets, user manuals etc.
- **Practical filters and configurators**
- **Direct inquiry functions**
You can make your inquiries directly via the product page.

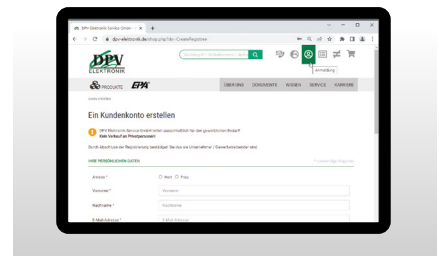

Advantageous delivery with flat-rate shipping costs

We deliver standard packages at a favorable price with a flat-rate shipping costs per order to the following countries

Germany:

5,90 € flat-rate shipping costs, no minimum order value

Belgium, Denmark, France, Luxembourg, the Netherlands, Austria, Poland, Czech Republic and Hungary:

10,- € flat-rate shipping costs, 50,- € minimum order value

Finland, Great Britain, Ireland, Italy, Latvia, Norway, Portugal, Romania, Sweden and Spain:

15,- € flat-rate shipping costs, 50,- € minimum order value

For other countries inside and outside the EU please contact us.

The flat-rate shipping costs are only valid for deliveries sent as standard package.

Volume-dependent deliveries, deliveries by forwarder and dangerous goods are excluded.

Delivery is unpaid ex warehouse including packaging. Delivery outside the EU only on request.

Our complete terms and conditions are available on our website:

www.dpv-elektronik.de/agb



*within Germany

For more than 30 years your system partner for electronics manufacturing



1997 – New building Herrengrundstrasse, Eppingen



2006 – Takeover of Compumet AG in Switzerland

Our milestones

1991	Start of business of DPV Elektronik-Service GmbH
1993	First trade fair presence at the productronica 1993
1994	Extension of the production and storage areas
1997 1998	New building of the head office in Herrengrundstrasse
2003	Extension of the logistics area
2005	Further extension of the logistics area
2006	Takeover of Compumet AG (Switzerland)
2008	New building – triplication of the plant area
2012	Installation of the photovoltaic system
2017 2018	New building of the logistics center Tiefental – site 2
2021	Anniversary: 30 years of DPV Elektronik-Service GmbH

30 years of DPV Elektronik-Service

DPV Elektronik-Service GmbH celebrated its 30th anniversary in 2021. We have been your reliable partner for ESD protection and production equipment for 30 years.

In January 1991, DPV Elektronik-Service GmbH started its business activity with the focus on the production and distribution of manufacturing equipment for the electronics industry. Having a product range of yet more than 1,000 articles, we already supplied our customers all over the world at that time.

The demand of our customers has steadily risen and we have been able to extend our product range continuously to more than 30,000 articles until today.

International fairs

Already in 1993, we presented our products on an international trade fair, the productronica, for the first time and have been regularly present on different trade fairs since that time.

Head office

As a result of the increasing demand and the enlargement of the product range the previous business rooms became too small despite several extensions.

A further extension was impossible. We planned a new building and could move to Herrengrundstrasse in Eppingen in 1998. The new site offered also enough space for future extensions.

Our subsidiary Compumet AG

Expanding our international business activity we took over Compumet AG located in Rheinfelden, Switzerland, in 2006. Our subsidiary Compumet AG supports and supplies our clients in Switzerland and Liechtenstein.

ESD protection from the beginning



2008 – Triplication of the plant area



2018 – New building site 2, logistics center Tiefental

Logistics center Tiefental – site 2

Despite continuous extensions the production and storage areas soon became too small. In 2017, 3 kilometers from the head office in the industrial area Tiefental, in cooperation with the Fraunhofer Institut, a highly automated logistics center with laboratory and offices was built allowing us to supply you as our customer even better, faster and more efficiently.

Training courses and further training – ESD protection from the beginning

The employees' knowledge plays an important role in the ESD protection. In our trainings and workshops we impart the knowledge that is important for the ESD safety, from the basics to the practical application.

Services in the field of ESD protection and auditing

We are pleased to advise you imparting our experiences and knowledge concerning ESD safety. We provide support to perform an analysis, make a plan, organize ESD trainings and implement the ESD control program. A regular control and auditing of the ESD protective measures ensure their functionality. Our qualified auditors verify the application of the protective measures implemented in compliance with the ESD control program.

Innovative solutions

Quality, longevity and functionality in the industrial environment characterize our products and are important to us. An experience of 30 years in the field of ESD protection allows us developing, in cooperation with our customers, new innovative products and improving existing ones. Many of our products can often be adapted to special customer requirements even in smaller quantities.

Environmental protection and sustainability

Environmental protection and sustainability are important issues for us.

Since 2012 a photovoltaic system installed on the roof of the head office in Eppingen has been satisfied more than 50% of our own power consumption.

Our server rooms and offices are air-conditioned by an absorption refrigeration system using the waste heat of a blocktype thermal power station. With this we satisfy 40% of our energy consumption for the air conditioning. Recyclable packaging materials are used for shipping.

Quality management according to ISO 9001:2015

Quality is important to us – we are a company certified by DEKRA according to ISO 9001. We continuously verify the quality of our products in our laboratory.



EPA® Our brand for your ESD safety



ESD work coats, Jackets & T-shirts
More comfort and safety at work



EPA® wear ESD work coats, jackets and T-shirts

Dissipative EPAwear® workwear for protection against electrostatic charge, ESD-safe according to IEC (DIN EN) 61340-5-1.

- Large selection of dimensionally stable ESD work coats and jackets in numerous designs designs, high-quality workmanship and with double seam for continuous conductivity
- PremiumSmooth shirts made from particularly soft, supple and moisture-absorbing cotton moisture-absorbing cotton mixed fabric for durability and maximum comfort



ESD-compatible work gloves
More protection and safety for ESD-sensitive environments



EPA® glove ESD-compatible Work gloves

EPAglove® ESD gloves protect your products from the effects of electrostatic discharge.

- Meet strict requirements for electrostatic discharge capacity
- Various breathable textile mixed fabrics for different areas of application in ESD protection zones
- Perfect fit, supple with seamless processing for an excellent tactile feel
- Also with PU-coated fingertips or palms



ESD Swivel Chairs, Stools and Standing Aids
Enhanced Safety and Convenience for Your ESD Protection Zones

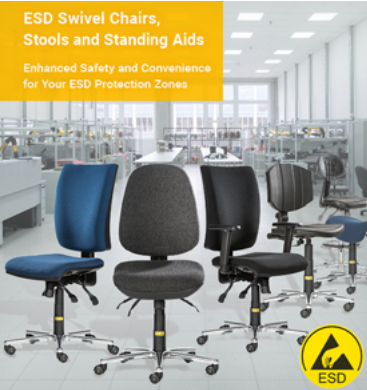

EPA® chair ESD Work swivel chairs

The EPAchair® work swivel chairs, stools and standing aids comply with the ESD standard IEC (DIN EN) 61340-5-1 and offer a high level of comfort at the best price-performance ratio.

- Large selection of swivel chairs, stools and standing aids
- Optimum seating comfort for your employees in the laboratory, office or production
- High quality standard and long service life
- Wide range of adjustment options for an individual sitting experience



Networkable ESD Personnel grounding control system
More security and comfort for your ESD protected zones



EPA® pro Networkable personal grounding control system

The innovative, networkable personal grounding test system with optional EPA zone access control for measuring, analyzing and sustainable documentation of the data. Complies with IEC (DIN EN) 61340-5-1, ANSI ESD S20.20 and GDPR.

- Central management of devices and data in one database
- Extensive export and import functions
- REST API interface for data connection to third-party systems
- Integrated multi-RFID reader

Guaranteed to comply with standards according to DIN EN 61340-5-1

EPA[®]clean ESD-compliant cleaning

Products from the EPAclean[®] range ensure that floors and surfaces in the EPA in the EPA remain clean, functional and retain their ESD protective properties.

- Ready-to-use cleaners for quick and easy cleaning of all ESD surfaces
- Concentrates for intensive basic cleaning of ESD floors suitable for stubborn dirt and wax residues
- High-yield concentrates for the daily care of ESD floors

EPA[®]pack ESD packaging solutions

ESD-sensitive components and assemblies are safely protected from electrostatic influences in shielding bags, DRY-Shield bags and packaging from the EPApack[®] series.

- Metallized DRY-Shield shielding bags and accessories
- Large selection of dissipative, conductive and shielding film foam and bubble bags – also available in rolls
- Dissipative ESD foam inserts for shipping boxes
- EPA[®]vacuboy ESD vacuum packaging machines

EPA[®]store ESD Parting inserts

The products in the EPAstore[®] series ensure ESD safety when storing and transporting components and assemblies.

- Optimum and ESD-protected storage of your products with containers, interlayers and parting inserts
- 200 different standard solutions for Euro and KLT containers
- Three different, permanently conductive materials and thicknesses
- Customized packaging solutions with printing or hot stamping can be configured via our online shop

EPA[®]move ESD Transport Trolleys

The sturdy and durable EPAmove[®] transport trolleys ensure ESD-safe transportation within your production facility.

- ESD transport trolley type 700 Maxi FLEX in various standard dimensions or individually configurable dimensions
- ESD transport trolleys with or without brackets and ESD folding trolleys
- ESD shelf trolleys for safe transportation on several shelves
- ESD transport trolleys in various designs



ESD protected area

Wherever people move or material is moved, electrostatic charge is generated. Electronic assemblies with an increasingly smaller structure can be damaged or destroyed by electrostatic discharge. As electrostatic charge cannot be felt or easily measured with a multimeter, these risks have to be assessed professionally.

The components damaged by electrostatic discharge can lead to a failure or a shortened service life of the affected assemblies. In order to prevent electrostatic charge of people and material, ESD protection measures are required. The aim is to prevent charge by grounding and slowly discharge charged material.

Areas designed in such a way that electronic assemblies can be handled safely are referred to as ESD protected zones or EPA (Electrostatic Protected Area). These areas are specially marked.

Regardless of the equipment of the ESD protection zone, additional measures must be observed:

- ESD-sensitive components (ESDS) may only be processed in the ESD protection zone (EPA)
- Ensure personal grounding via wrist strap and ESD shoes
- Wear dissipative clothing covering other clothes

- Avoid electrostatically chargeable materials such as PE, PVC, polystyrene etc.
- Electrostatic fields of > 5000 volts/m have to be avoided
- Use only labelled ESD packaging and transport containers
- Only ESD-trained personnel may be employed in EPA protection zones

Regular monitoring of the protective functions in the EPA ensures safe processing of electronics.

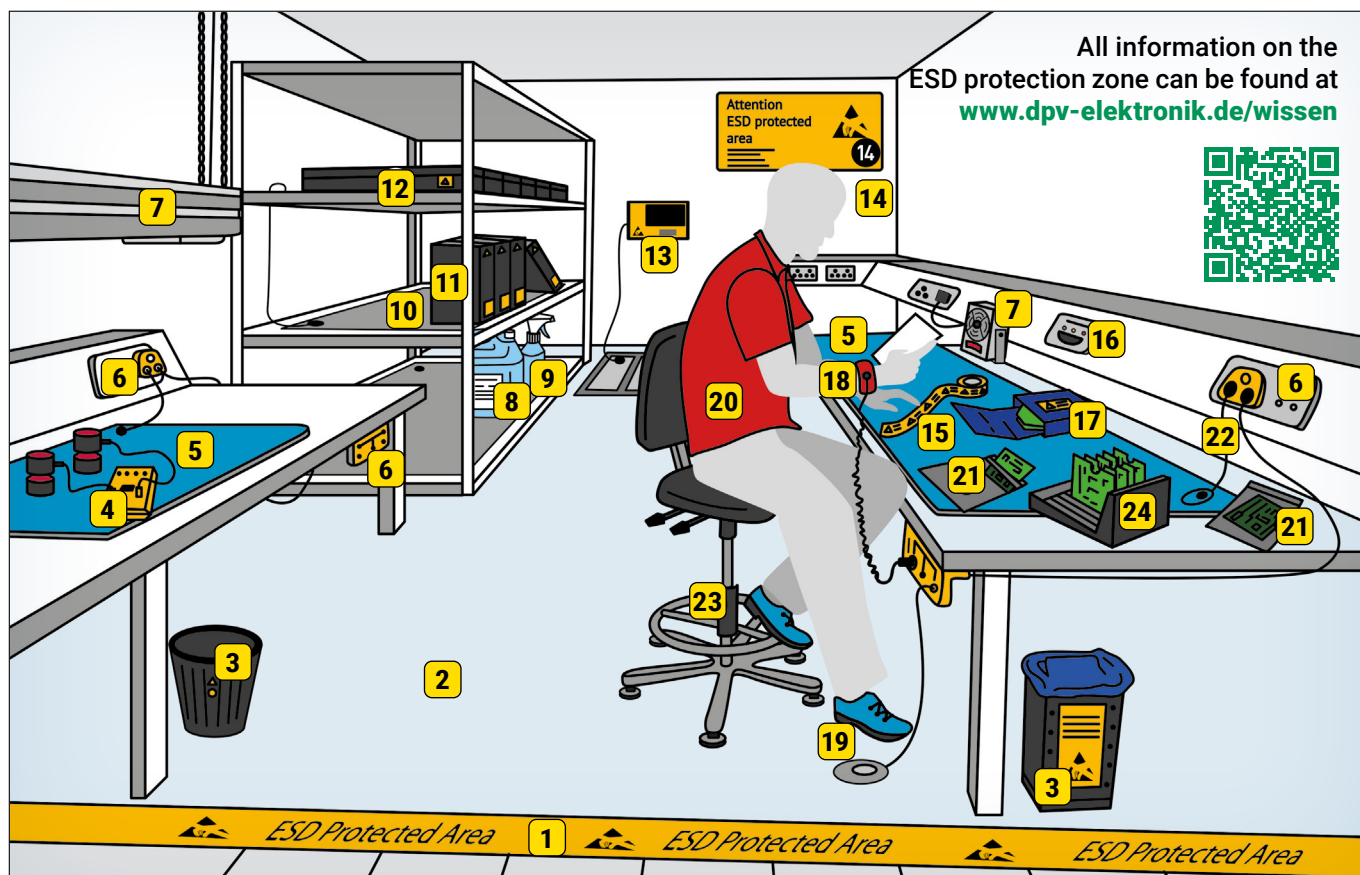

All information on the ESD protection zone can be found at www.dpv-elektronik.de/wissen



- | | | | |
|---------------------------------|--------------------------------------|----------------------------|-------------------------|
| 1. Floor marking | 7. Ionizing equipment | 13. Personnel test station | 19. Heel straps / shoes |
| 2. Floor coverings | 8. Cleaner for floor covering | 14. Warning signs | 20. Clothes |
| 3. Wastepaper basket | 9. Cleaner for table covering | 15. Warning labels | 21. Film bags |
| 4. Test and measuring equipment | 10. Shelf coverings | 16. Permanent monitoring | 22. Grounding cables |
| 5. Table coverings | 11. Ring folder and document holders | 17. Shipping boxes | 23. Chairs |
| 6. Grounding boxes | 12. Containers | 18. Wrist straps | 24. PCB holders |

ESD-Management



ESD safety prevents damage to your of your products due to static charges. In electronics production, there are many areas where static charges can occur. Particularly in systems and machines can be subject to conditions that can lead to ESD-related damage.

We will provide you with comprehensive information on this and train your employees accordingly. We analyze and evaluate the existing situation in your production and support you with the creation or supplementation of your ESD control program. The scope of the consultation will be agreed with you as required.

To monitor the implementation and application of the ESD control program ESD protection measures, we offer you auditing in accordance with applicable norms and standards. On special topics such as "ESD safety in machines and systems and systems", we offer workshops, also at your on your premises.

Our services

- ESD consultation
- ESD audit
- ESD service
- ESD training



Certificates and test reports

Our own brands:



Scan the QR code and find more products and information online, or take a look at the online catalog.



dpv-elektronik.de/Products/ESD-Management

ESD shoes

Safety at every turn! Our ESD safety shoes not only offer maximum comfort, but also protect against electrostatic discharge. Developed for professional use in sensitive working environments such as the electronics or pharmaceutical industries, they guarantee reliable protection for you and your sensitive equipment. Robust, antistatic and equipped with a slip-resistant sole, our ESD safety shoes are the first choice for anyone who value safety and comfort in equal measure.

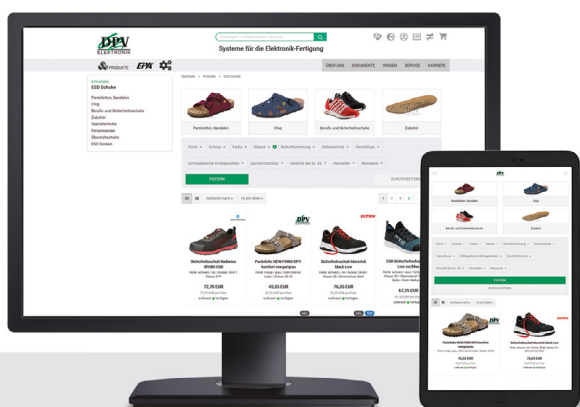

Filter our range of shoes according to your requirements

- Use our shoe filter to quickly find the suitable shoe in our webshop
- Simple search in the complete range of work and safety shoes
- Many filter criteria for optimal selection

Use our online shoe filter – with just a few clicks to the right shoe!



Systems against Electrostatics



ESD Footwear

Overview of safety classes	12
Find your shoe quickly and easily!	12
DPV Komfort	13
BIRKENSTOCK	17
ABEBA	19
JALAS	34
SIEVI	41
LUPOS	47
U-POWER	49
ELTEN	54
ATLAS	64
UVEX	70
PUMA	76
ALBATROS	80
LEMAITRE	84
STEITZ SECURA	86
FTG Safety shoes	90
BATA	93
BAAK	96
Orthopedic insoles	101

ESD socks

ESD Socks	102
-----------	-----

Care products

Shoe care products	103
--------------------	-----

Heel grounders and overshoes

Overshoes	104
Heel grounders	106

Sole cleaning

Tacky mats	108
------------	-----

Workwear

ESD Work coats	109
ESD Shirts	119
ESD Polo shirts	120
ESD Sweatshirts and sweat jackets	121
Coolmax® ALL SEASON	124
PremiumSmooth	126
ESD Jackets and vests	128
ESD Trousers	130
Caps and scarfs ESD	130
Cleanroom clothing	131
Disposable clothes	133
ID card holders	136

ESD Gloves

Gloves EPAGlove® LEO textile	137
Gloves EPAGlove® CARBON textile	138
Gloves EPAGlove® COPPER textile	139
Gloves polyester	140
Gloves TEGERA	141
Uvex gloves	145
Disposable gloves	146
Finger cots	146

ESD Swivel chairs EPChair®

ESD Swivel chairs EPChair®	147
Swivel chairs CLASSIC EPChair®	149
ESD swivel stools	151

Measurement and test equipment

EPApro® Personnel Tester 1000	153
EPA Access control system	156
Personnel test stations	158

EPAClean® Cleaning supplies

EPAClean® Cleaning supplies	161
-----------------------------	-----

ESD Footwear

Safety shoe classes at a glance

Professional and safety shoes have to withstand the requirements in different working areas every day. The standards EN ISO 20347 for professional footwear and EN ISO 20345 for safety footwear are to assure homogenous safety standards. The selection of the appropriate shoes is made on the basis of the risks for the relevant application. You will receive information about this subject from the security officers in your company and the relevant trade associations.

EN ISO 20347 for professional footwear

The standard EN ISO 20347 defines the basic and additional requirements for professional footwear that are not subject to mechanical risks (by impact or pressure). Professional footwear according to EN ISO 20347 is normally produced without toe cap.

OB All basic requirements

O1 In addition to OB: closed heel, antistatic, energy absorption capacity in the heel

O2 In addition to O1: water penetrability, water absorption

EN ISO 20345 for safety shoes

Safety shoes are produced according to the standard EN ISO 20345 and offer the wearer the highest possible protection. The processed protective toe and heel caps are certified for high stress caused by an impact or pressure effect of 200 Joule.

SB All basic requirements

S1 Additionally to SB: closed heel, antistatic, energy absorption capacity in the heel, fuel resistance

S1P In addition to S1P: midsole with penetration protection

S2 In addition to S1: water penetrability, water absorption

S3 In addition to S2: midsole with penetration protection, profiled outsole

DGUV standard 112-191 - orthopedic insoles for safety shoes

Since 2007 the **DGUV standard 112-191 (formerly BGR 191)** has clearly regulated the use of orthopedic insoles in safety shoe and the individual finishing of safety shoes. According to the standard, only modifications of the safety shoe approved by a certified testing authority and attested by an EC type examination certificate are permitted.

Especially in case of shoes having to fulfill the ESD standard EN 61340-5-1, the use of certified orthopedic insoles is essential as those ensure the necessary contact and assure all in all the required ESD protection.



All shoes with this icon have been certified by the respective manufacturer according to the DGUV standard 121-191.



Find your shoe quickly and easily!

- Find the appropriate shoe quickly with our **shoe filter** in our **online shop**
- **simple search** in the complete product range of professional and safety shoes
- **many filter criteria** for optimal selection

Use our shoe filter online - with a few clicks to the appropriate shoe!

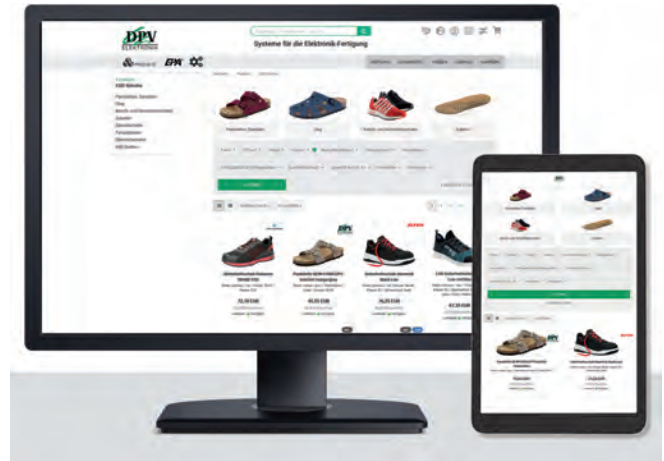

Filter according to the requirements for your shoe:

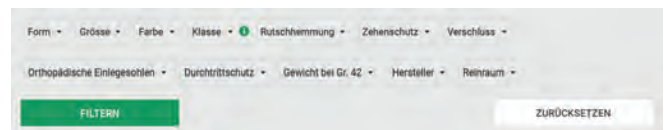

- Manufacturer
- Size
- Color
- Shoe shape
- Professional and safety class
- Slip resistance
- Penetration protection
- Suitability for orthopedic insoles

You will find more information about the requirements directly in the filter.

Filter now and find the appropriate shoe...

Reliably tested!

The EPApro® ESD Personnel Tester 1000 allows testing your safety shoe reliably, simply and in less than 2 seconds before entering in the ESD-protected zone.

Further information about the EPApro® 1000 are available in the **catalog pages 144-146** or **online with the *dpvlink* 21010**



DPV-komfort

für besten Tragekomfort

DPV professional footwear is antistatic and offers highest wearing comfort for the daily work.

During the treatment high-quality natural material are used ensuring superior quality and environmental compatibility.

For the upper nubuck or smooth leather is used. The footbed of the DPV professional shoes is made of cork, jute and natural latex and has an air cushion pad in the heel. Its special treatment makes the footbed lightweight and flexible. Therefore, it adapts to the natural movement of the foot and ensures a soft treat. All professional shoes have a volume conductive, slip- and abrasion-resistant PU outsole and a suede insole with integrated vulcanized conductive contact points.

In compliance with the ESD standard DIN EN 61340-5-1 



 **ESD approved shoes**
in accordance with EN 61340

 **100% metal-free shoe**

 **Work shoes OB**
in accordance with EN ISO 20347

 **Exchangeable insole**

Slippers, sandals

Slipper STYLE DPV-komfort



Slipper, adjustable buckle at the instep; air cushion cork footbed. DIN EN ISO 20347.



dpvlink 22591

Article	Color	Upper	Size
2505.026.K966	black / Motif print	nubuck / leather	36-42



Women's slipper with three buckles DPV-komfort



Women's slipper with three buckles; air cushion cork footbed; DIN EN ISO 20347.



dpvlink 13042

Article	Color	Upper	Size
2505.021.K956	black / Motif print	nubuck	36-42



Women's slipper with wedge heel DPV-komfort



Women's slipper, three buckles with wedge heel, nubuck; air cushion cork footbed; DIN EN ISO 20347.



dpvlink 16751

Article	Color	Upper	Size
2505.025.K56	black	nubuck	36-42



Slipper DPV-komfort



Women's / men's slipper with velcro fastener; air cushion cork footbed; DIN EN ISO 20347.



metallfrei



dpvlink 9723

Article	Color	Upper	Size
2505.030.K56	black	nubuck	36-41
2505.030.K59	marine	nubuck	36-41
2505.030.51	navy	nubuck	36-41
2505.030-1.51	navy	nubuck	42-48

Woman's slipper with velcro fastener DPV-komfort



Women's slipper, adjustable velcro fastener, nubuck, metal-free, wedge heel, air cushion cork footbed; DIN EN ISO 20347.



metallfrei



dpvlink 16748

Article	Color	Upper	Size
2505.122.K56	black	nubuck	35-42
2505.122.K59	marine	nubuck	35-42

Women's slipper DPV-komfort



Women's slipper with wedge heel, two buckles; air cushion cork footbed, DIN EN ISO 20347.



dpvlink 012

Article	Color	Upper	Size
2505.012.K717	purple	nubuck	36-42
2505.012.16	black	leather	36-42
2505.012.51	navy	nubuck	36-42
2505.012.00	white	leather	36-42

Slipper DPV-komfort



Women's / men's slipper with two buckles; air cushion cork footbed; DIN EN ISO 20347.



dpvlink 005

Article	Color	Upper	Size
2505.011.51	navy	nubuck	35-41
2505.011-1.51	navy	nubuck	42-48
2505.011.K722	berry	nubuck	35-41
2505.011.K725	stone grey	nubuck	35-41
2505.011-1.K725	stone grey	nubuck	42-48
2505.011.00	white	leather	35-41
2505.011-1.00	white	leather	42-48
2505.011.11	blue	leather	35-41
2505.011-1.11	blue	leather	42-48
2505.011.16	black	leather	35-41
2505.011-1.16	black	leather	42-48

Sandal with heel strap DPV-komfort



Women's and men's sandal with heel strap, two buckles; air cushion cork footbed. DIN EN ISO 20347.



dpvlink 018

Article	Color	Upper	Size
2505.101.16	black	leather	35-41
2505.101-1.16	black	leather	42-48
2505.101.11	blue	leather	35-41
2505.101-1.11	blue	leather	42-48
2505.101.00	white	leather	35-41
2505.101-1.00	white	leather	42-48
2505.101.51	navy	nubuck	35-41
2505.101-1.51	navy	nubuck	42-48

Men's slipper / sandal DPV-komfort



Men's slipper / sandal, upper nubuck, adjustable velcro fastener and sturdy PU outsole; exchangeable air cushion cork footbed comfort. DIN EN ISO 20347.



dpvlink 002

Article	Color	Size	Closure	Upper
2505.075-1.57	asphalt	40-46		nubuck
2505.175-1.57	asphalt	40-46	with heel strap	nubuck



Men's slipper / sandal DPV-komfort



Men's slipper / sandal, upper nubuck, with sturdy PU outsole and exchangeable air cushion cork footbed. DIN EN ISO 20347.



dpvlink 163

Article	Color	Size	Closure	Upper
2505.065-1.51	navy	40-46		nubuck
2505.166-1.51	navy	40-46	with heel strap	nubuck



Clogs

Clog AIR DPV-komfort



Clog with perforation, foldable heel strap, air cushion cork footbed. DIN EN ISO 20347.



dpvlink 13047

Article	Color	Upper	Size
2505.271.K728	moss grey	nubuck	36-42
2505.271-1.K728	moss grey	nubuck	43-48
2505.271.K722	berry	nubuck	36-42
2505.271-1.51	navy	nubuck	43-48
2505.271.K725	stone grey	nubuck	36-42
2505.271-1.K725	stone grey	nubuck	43-48
2505.271.K717	purple	nubuck	36-42
2505.271.K713	apple	nubuck	36-42
2505.271.K56	black	nubuck	36-42
2505.271-1.K56	black	nubuck	43-48
2505.271.K59	marine	nubuck	36-42
2505.271.K718	pink	nubuck	36-42



Clog DPV-komfort with perforation



Women's / Men's clog with perforation; air cushion cork footbed and cowhide upper leather. DIN EN ISO 20347.



dpvlink 055

Article	Color	Upper	Size
2505.211.K725	stone grey	nubuck	36-41
2505.211-1.K725	stone grey	nubuck	42-48
2505.211.16	black	leather	35-41
2505.211-1.16	black	leather	42-48
2505.211.00	white	leather	35-41
2505.211-1.00	white	leather	42-48
2505.211.51	navy	nubuck	35-41
2505.211-1.51	navy	nubuck	42-48
2505.211.11	blue	leather	35-41
2505.211-1.11	blue	leather	42-48



Clog DPV-komfort



Women's / Men's clog with instep strap; full-grain leather and air cushion cork footbed. DIN EN ISO 20347.



dpvlink 033

Article	Color	Upper	Size
2505.201.51	navy	nubuck	35-41
2505.201-1.51	navy	nubuck	42-48
2505.201.11	blue	leather	35-41
2505.201-1.11	blue	leather	42-48
2505.201.16	black	leather	35-41
2505.201-1.16	black	leather	42-48
2505.201.00	white	leather	35-41
2505.201-1.00	white	leather	42-48
2505.201.K56	black	nubuck	35-42
2505.201.K59	marine	nubuck	35-42



Clog with heel strap DPV-komfort



Women's / Men's clog with heel strap; perforation; cowhide upper leather; air cushion cork footbed. DIN EN ISO 20347.



dpvlink 079

Article	Color	Upper	Size
2505.261.16	black	leather	35-41
2505.261-1.16	black	leather	42-48
2505.261.K725	stone grey	nubuck	36-41
2505.261-1.K725	stone grey	nubuck	42-48
2505.261.00	white	leather	35-41
2505.261-1.00	white	leather	42-48
2505.261.11	blue	leather	35-41
2505.261-1.11	blue	leather	42-48
2505.261.51	navy	nubuck	35-41
2505.261-1.51	navy	nubuck	42-48



Clog with heel strap DPV-komfort



Women's / Men's clog with heel strap; air cushion cork footbed; cowhide upper leather. DIN EN ISO 20347.



dpvlink 068

Article	Color	Upper	Size
2505.251.11	blue	leather	35-41
2505.251-1.11	blue	leather	42-48
2505.251.00	white	leather	35-41
2505.251-1.00	white	leather	42-48
2505.251.51	navy	nubuck	35-41
2505.251-1.51	navy	nubuck	42-48
2505.251.16	black	leather	35-41
2505.251-1.16	black	leather	42-48



BIRKENSTOCK®

PROFESSIONAL



For many years BIRKENSTOCK has been synonymous for excellent comfort and extraordinary quality, also in the ESD sector, all over the world. Due to their additional ESD features, the ESD shoes ensure a reliable protection against spontaneous static discharge and are therefore ideal for the use in EPAs. For their manufacturing BIRKENSTOCK uses high-quality materials from Europe. The outsole are highly slip- and abrasion-resistant providing good shock absorption. The unique BIRKENSTOCK footbed Professional adapts perfectly to the sole of the foot due to its surface structure. Thereby it supports the foot offering the wearer best wearing comfort even during long working days.

In compliance with the ESD standard DIN EN 61340-5-1 

Optimale Passform durch zwei Weiten



für normale kräftige Füße



für schmale schlanke Füße



ESD approved shoes
in accordance with EN 61340



Work shoes OB
in accordance with EN ISO 20347



Work shoes O2
in accordance with EN ISO 20347



Safety shoes S3
in accordance with EN ISO 20345



Steel toe cap



Slip resistance SRC
in accordance with EN 13287



Penetration protection metal-free



Exchangeable insole

Slippers, sandals, clogs

Arizona ESD Birko-Flor



Slipper Arizona ESD, with two buckles; original BIRKENSTOCK footbed with completely conductive bedding; upper material Birko-Flor [BF]. DIN EN ISO 20347.



OB

dpvlink 24885

Article	Color	Standard width	Size
Arizona ESD Birko-Flor			
1021411	rose / Motif print	slim	35-43
1021400	light blue / Motif print	slim	35-43



Arizona ESD Birko-Flor



Slipper Arizona ESD, with two buckles; BIRKENSTOCK footbed with completely conductive bedding, upper material Birko-Flor [BF]. DIN EN ISO 20347.



OB

dpvlink 17527

Article	Color	Standard width	Size
Arizona ESD Birko-Flor			
089430	blue	normal	35-46
089430-1	blue	normal	47-48
089438	blue	slim	35-46
089438-1	blue	slim	47-48
089410	white	normal	36-46
089410-1	white	normal	47-48
089418	white	slim	35-46
089418-1	white	slim	47-48
089420	black	normal	35-46
089420-1	black	normal	47-48
089428	black	slim	35-46
089428-1	black	slim	47-48



Milano ESD Birko-Flor



Sandal Milano ESD, with two buckles and heel strap; BIRKENSTOCK footbed with completely conductive bedding; upper material Birko-Flor. DIN EN ISO 20347.



OB

dpvlink 17544

Article	Color	Standard width	Size
Milano ESD Birko-Flor			
634790	black	normal	35-46
634790-1	black	normal	47-48
634798	black	slim	35-46
634798-1	black	slim	47-48



Kay ESD Birko-Flor



Clog ESD, instep strap with buckle, foldable heel strap; BIRKENSTOCK footbed with completely conductive bedding, upper material Birko-Flor. DIN EN ISO 20347.



OB

dpvlink 24888

Article	Color	Standard width	Size
Kay ESD Birko-Flor			
1020876	light blue / Motif print	slim	35-43
1020945	rose / Motif print	slim	35-43



Boston ESD leather



Clog Boston ESD, instep strap with buckle; original BIRKENSTOCK footbed with completely conductive bedding; upper material genuine leather, breathable. DIN EN ISO 20347.



dpvlink 17557

Article	Color	Standard width	Size
Boston ESD leather			
061380	blue	normal	39-46
061380-1	blue	normal	47-48
061388	blue	slim	36-42
061370	white	normal	39-46
061370-1	white	normal	47-48
061378	white	slim	36-42
061360	black	normal	39-46
061360-1	black	normal	47-48
061368	black	slim	36-42

Tokio ESD leather



Clog Tokio ESD, instep strap with buckle; heel strap; original BIRKENSTOCK footbed with completely conductive bedding; upper material genuine leather, breathable. DIN EN ISO 20347.



dpvlink 17564

Article	Color	Standard width	Size
Tokio ESD leather			
061400	black	normal	39-46
061400-1	black	normal	47-48
061408	black	slim	36-42
061390	blue	normal	39-46
061390-1	blue	normal	47-48
061398	blue	slim	36-42
061410	white	normal	39-46
061410-1	white	normal	47-48
061418	white	slim	36-42

Linz ESD leather



Clog Linz ESD, closed heel area / velcro fastener; original BIRKENSTOCK footbed with completely conductive bedding; upper material leather, breathable. DIN EN ISO 20347.



dpvlink 17576

Article	Color	Standard width	Size
Linz ESD leather			
583160	black	normal	39-46
583168	black	slim	36-42
583150	white	normal	39-46
583158	white	slim	36-42

Professional and safety footwear

Sneaker QO / QS 500 ESD



Sneaker QO 500 ESD 02; original BIRKENSTOCK footbed with completely conductive bedding; upper leather; nitrile/caoutchouc outsole, oil- and fuel-resistant, slip-resistant (SRC)

Variant safety shoe QS 500 ESD S3 additionally with steel toe cap; scratch-resistant tip protection; penetration protection (metal-free)



dpvlink 21174

Article	Color	Size	Category	Protective toe cap
Sneaker QO / QS 500 ESD				
1011365	black	35-46	O2	none
1011365-1	black	47-48	O2	none
1011366	white	35-46	O2	none
1011366-1	white	47-48	O2	none
1011363	black	35-46	S3	steel
1011363-1	black	47-48	S3	steel
1011364	white	35-46	S3	steel
1011364-1	white	47-48	S3	steel



ABEBA is one of the largest and most modern shoe manufacturers in Europe. The company attaches great importance to superior quality and therefore makes high demands on the used materials and their treatment. Its professional and safety footwear combines optimal protective function, a healthy foot climate and maximal wearing comfort. ABEBA's product range of ESD shoes comprises a variety of different shoe models. All shoes, from the slipper to the safety shoe, have a slip-resistant outsole and offer a reliable ESD protection.

In compliance with the ESD standard DIN EN 61340-5-1 



 **ESD approved shoes**
in accordance with EN 61340

 **Work shoes OB**
in accordance with EN ISO 20347

 **Work shoes O1**
in accordance with EN ISO 20347

 **Work shoes O2**
in accordance with EN ISO 20347

 **Safety shoes SB**
in accordance with EN ISO 20345

 **Safety shoes S1**
in accordance with EN ISO 20345

 **Safety shoes S1P**
in accordance with EN ISO 20345

 **Safety shoes S2**
in accordance with EN ISO 20345

 **Safety shoes S3**
in accordance with EN ISO 20345

 **Steel toe cap**

 **Metal-free toe cap**

 **Slip resistance SRA**
in accordance with EN 13287

 **Slip resistance SRB**
in accordance with EN 13287

 **Slip resistance SRC**
in accordance with EN 13287

 **Penetration protection steel**

 **Penetration protection metal-free**

 **100% metal-free shoe**

 **Overcap**
Toe wear protection

 **Washable shoe**

 **Exchangeable insole**

 **DGVU standard 112-191**
Suitable for orthopedic insoles in accordance with DGVU standard 112-191

 **Suitable for steam sterilization**
Autoclavable (up to 135°C)

 **Hazard Analysis Critical Control Points**

 **Breathable**
(Breathable lining)

 **Raised sole possible**

Slippers, sandals, clogs

Slipper / sandal NATURE 

Slipper with two adjustable instep strap with velcro fastener; upper leather; cork footbed; metal-free; no lining; leather-covered; oil and benzene-resistant, acid- and alkali-resistant special rubber outsole, slip-resistant (SRC).



dpmlink 1003

Article	Color	Size	Category	Form
Slipper / sandal NATURE				
AB-4085	black	34-48	OB	slipper
AB-4080	white	34-48	OB	slipper
AB-4090	white	34-48	OB	sandal

Slipper / Sandal NATURE 

Slipper / sandal with two adjustable instep straps; upper nubuck leather; metal-free, no lining; cork footbed; leather covered; oil- and benzene-resistant, acid- and alkali-resistant outsole of special rubber, slip-resistant (SRC).



dpmlink 15893

Article	Color	Size	Category	Form
Slipper / Sandal NATURE				
AB-4086	blue	34-48	OB	slipper
AB-4096	blue	34-48	OB	sandal

Women's slipper Reflexor 

Women's slipper; upper and lining leather; hand-sewn seam; extremely light PU outsole, fuel-resistant; fixed Reflexor® footbed, slip-resistant.



dpmlink 14360

Article	Color	Size
Women's slipper Reflexor		
AB-31092	black	36-42

Women's slipper Reflexor



Women's slipper with three adjustable instep straps with velcro fastener: upper smooth leather and leather lining; hand-sewn seam; extremely light PU outsole, fuel-resistant, slip-resistant (SRC).



Reflexor



dpvlink 964



Article	Color	Size	Category
Women's slipper Reflexor			
AB-36912	black	36-42	OB
AB-36902	white	36-42	OB

Clog with heel strap NATURE



Clog with fixed heel strap with adjustable instep strap; upper leather; no lining; cork footbed, leather-covered; oil- and benzene-resistant, acid- and alkali-resistant special rubber outsole, slip-resistant (SRC).



NATURE



dpvlink 983



Article	Color	Size	Category	Upper
Clog with heel strap NATURE				
AB-4055	black	34-48	OB	leather
AB-4040	white	34-48	OB	leather
AB-4045	night blue	34-48	OB	leather / perforated
AB-4050	white	34-48	OB	leather / perforated

Clog with heel strap the ORIGINAL



Clog with top layer microfiber; adjustable foldable heel strap: upper material A-micro (microfiber); slip-resistant TPU outsole; TPU outsole, slip-resistant (SRC).



the ORIGINAL



dpvlink 17413



Article	Color	Size	Category	Upper
Clog with heel strap the ORIGINAL				
AB-37520	white	36-42	OB	microfiber / perforated
AB-37530	black	36-42	OB	microfiber / perforated

Clog with heel strap x-light



Clog with adjustable and foldable heel strap. Elastic band over instep; upper smooth leather; lining with silver ions: sanitized treated; oil- and benzene-resistant PU outsole, slip-resistant (SRC).



x-light



dpvlink 22608



Article	Color	Size	Category
Clog with heel strap x-light			
AB-7131141	white	35-48	OB
AB-7131142	black	35-48	OB

Clog with heel strap x-light



Clog with elastic band over instep. Fixed, adjustable heel strap with velcro fastener; upper smooth leather; lining with silver ions; oil- and fuel-resistant PU outsole, slip-resistant. OB FO SRC; EN ISO 20347:2012



x-light



dpvlink 22697



Article	Color	Size	Category
Clog with heel strap x-light			
AB-7131135	black	35-48	OB
AB-7131130	white	35-48	OB

Clog with heel strap DYNAMIC



Clog with fixed heel strap; upper knitted textile; water-repellent; breathable lining; oil- and fuel-resistant TPU outsole, slip-resistant (SRC).



DYNAMIC



dpvlink 22850



Article	Color	Size	Category
Clog with heel strap DYNAMIC			
AB-37326	light blue / white	35-48	OB
AB-37328	anthracite / white	35-48	OB
AB-37329	white	35-48	OB

Clog with heel strap DYNAMIC 

Clog with adjustable, foldable heel strap: upper material smooth leather; moisture-absorbing lining; functional joint stabilizer; oil- and benzine-resistant outsole, ABEBA special profile, slip-resistant (SRC).



DYNAMIC



dpvlink 16640

Article	Color	Size	Category
Clog with heel strap DYNAMIC			
AB-37310	white	35-48	OB
AB-37312	white / blue	35-48	OB
AB-37313	white / red	35-48	OB
AB-37315	black / brown	35-48	OB

Clog with heel strap DYNAMIC 

Clog with cushioning in the instep; adjustable fixed heel strap; upper material A-micro (microfiber); HACCP compatible; moisture-absorbent lining; functional joint stabilizer; oil- and benzine-resistant outsole, ABEBA special profile, slip-resistant (SRC).



DYNAMIC



dpvlink 16629

Article	Color	Size	Category
Clog with heel strap DYNAMIC			
AB-37331	black / blue	35-48	OB
AB-37332	black / red	35-48	OB
AB-37335	white / black	35-48	OB

Clog with heel strap DYNAMIC 

Clog with cushioning in the instep; adjustable fixed heel strap; upper material A-micro (microfiber); **breathable textile insert**; moisture-absorbing lining; functional joint stabilizer; oil- and benzine-resistant outsole, ABEBA special profile, slip-resistant (SRC).



DYNAMIC



dpvlink 16635

Article	Color	Size	Category
Clog with heel strap DYNAMIC			
AB-37341	black / blue	35-48	OB
AB-37345	white / black	35-48	OB
AB-37343	black / yellow	35-48	OB

Clog with heel strap DYNAMIC 

Clog with adjustable, fixed heel strap; upper material A-micro (microfiber); HACCP compatible; moisture-absorbing lining; functional joint stabilizer; oil- and benzine-resistant outsole, ABEBA special profile, slip-resistant (SRC).



DYNAMIC



dpvlink 16647

Article	Color	Size	Category
Clog with heel strap DYNAMIC			
AB-37361	black	35-48	OB
AB-37360	white	35-48	OB

Clog with heel strap DYNAMIC 

Clog with padding in the instep; adjustable fixed heel strap; upper microfiber; HACCP compliant; moisture-absorbing lining; oil- and fuel-resistant outsole; ABEBA special profile, slip-resistant (SRC).



DYNAMIC



dpvlink 21230

Article	Color	Size	Category
Clog with heel strap DYNAMIC			
AB-37320	white / Motif print	35-43	OB

Clog with heel strap easy 2.0



Clog with adjustable folding heel strap; upper smooth leather, replaceable insole; PRT FLEX technology; SHOCK ABSORBER technology; SELF CLEAN technology (self-cleaning outsole), oil and petrol resistant, anti-slip (SRC)



dpvlink 28070

Article	Color	Size	Category	Upper
Clog with heel strap easy 2.0				
AB-837620	white	35-48	OB	Microfiber patent
AB-837621	black	35-48	OB	Microfiber patent
AB-837622	white / blue	35-48	OB	leather



Clog with heel strap easy 2.0



Clog with adjustable folding heel strap; upper smooth leather, perforated; replaceable insole; PRT FLEX technology; SHOCK ABSORBER technology; SELF CLEAN technology (self-cleaning outsole), oil and petrol resistant, anti-slip (SRC)



dpvlink 28067

Article	Color	Size	Category
Clog with heel strap easy 2.0			
AB-837630	white	35-48	OB
AB-837631	black	35-48	OB



Clog with heel strap rubber



Clog with fixed adjustable heel strap and adjustable instep strap. Upper smooth leather; top layer leather; oil- and benzine-resistant, acid- and alkali-resistant rubber outsole, slip-resistant. OB A, SRC; EN ISO 20347:2007



dpvlink 140

Article	Color	Size	Category
Clog with heel strap rubber			
AB-5100	white	36-47	OB
AB-5150	marine	36-47	OB



Clog with heel strap rubber



Clog with adjustable and foldable heel strap. Upper smooth leather; perforated; top layer leather; oil- and benzine-resistant, acid- and alkali-resistant rubber outsole, slip-resistant (SRC).



dpvlink 137

Article	Color	Size	Category
Clog with heel strap rubber			
AB-5310	black	36-47	OB
AB-5300	white	36-47	OB



Clog with heel strap rubber



Clog with adjustable and foldable heel strap; upper smooth leather; oil- and benzine-resistant, acid- and alkali-resistant rubber outsole; slip-resistant. OB A, SRA; EN ISO 20347:2007



dpvlink 134

Article	Color	Size	Category
Clog with heel strap rubber			
AB-5200	white	36-47	OB
AB-5250	marine	36-47	OB



Clog with heel strap Arrow



Clog with top layer microfiber; adjustable foldable heel strap: upper material A-micro (microfiber), perforated; wear-resistant PU outsole, slip-resistant (SRA).



dpvlink 17419

Article	Color	Size	Category
Clog with heel strap Arrow			
AB-38330	black	36-47	OB



Clog with heel strap Arrow

Clog with fixed heel strap with velcro fastener. Upper smooth leather, perforated; elastic band over instep; lining leather; shock-absorbing PU midsole; abrasion-resistant, oil- and benzine-resistant PU compact outsole, slip-resistant (SRC).



Arrow



dpvlink 161

Article	Color	Size	Category
Clog with heel strap Arrow			
AB-38600	white	36-47	OB



Clog with heel strap Arrow

Clog with adjustable and foldable heel strap. Upper smooth leather; lining leather; top layer leather; shock-absorbing PU midsole; abrasion-resistant, oil- and benzine-resistant PU outsole, slip-resistant (SRA).



Arrow



dpvlink 976

Article	Color	Size	Category	Upper
Clog with heel strap Arrow				
AB-38200	white	36-47	OB	leather
AB-38202	white	48-51	OB	leather
AB-38210	black	36-47	OB	leather
AB-38212	black	48-51	OB	leather
AB-35600	white	36-47	OB	leather / perforated



Women's shoes XXL width

Women's sandal XXL

Women's sandal with adjustable heel strap; elastic band over instep; upper smooth leather, lining microfiber; hand-sewn seam; extremely light PU outsole, fuel-resistant, slip-resistant (SRB).



Reflexor



dpvlink 14417

Article	Color	Size	Category	Upper
Women's sandal XXL				
AB-36872	black	36-43	OB	nubuck



Women's clog XXL

Women's clog with adjustable and foldable heel strap; elastic band over instep; upper smooth leather, lining microfiber; hand-sewn seam; extremely light PU outsole, fuel-resistant, slip-resistant (SRB).



Reflexor



dpvlink 14420

Article	Color	Size	Category
Women's clog XXL			
AB-36813	black	36-43	OB



Professional and safety footwear

Loafer

Loafer with upper material A-micro (microfiber); lining with silver ions; elastic in the instep; HACCP-compliant; washable at 30°C, Soft-PU midsole; oil- and fuel-resistant TPU outsole with flex zones, slip-resistant (SRC).



dpvlink 18469

Article	Color	Size	Category
Loafer			
AB-36741	black	35-48	02
AB-36740	white	35-48	02

Safety shoe

Lace-up shoe. Upper textile (breathable); lining with silver ions (moisture-absorbing); puncture-resistant midsole (metal-free); oil- and fuel-resistant TPU outsole with flex zones, slip-resistant (SRC).



dpvlink 21249

Article	Color	Size	Category	Protective toe cap
Safety shoe				
AB-36728	black	35-48	02	none
AB-36729	white	35-48	02	none
AB-31628	black	35-48	S3	steel
AB-31629	white	35-48	S3	steel

Safety shoe

Lace-up shoe. Upper material smooth leather/suede; breathable textile inserts; reflector stripes; lining with silver ions; cushioned shaft edge and counter; functional joint stabilizer; Soft-PU midsole; oil- and fuel-resistant TPU outsole with flex zones, slip-resistant (SRC).



dpvlink 16704

Article	Color	Size	Category	Protective toe cap
Safety shoe				
AB-36721	black	35-48	01	none
AB-31721	black	35-48	S1	steel

Safety shoe

Lace-up shoe. Upper knitted textile (breathable); lining with silver ions (moisture-absorbing); protective coating in toe area; midsole Soft-PU; oil- and fuel-resistant TPU outsole with flex zones, slip-resistant (SRC).

Variant safety shoe S2 and S3 additionally with steel toe cap



dpvlink 21251

Article	Color	Size	Category	Protective toe cap
Safety shoe				
AB-36774	orange	35-48	02	none
AB-36772	white	35-48	02	none
AB-36773	blue	35-48	02	none
AB-36775	anthracite	35-48	02	none
AB-36776	black	35-48	02	none
AB-31772	white	35-48	S2	steel
AB-31773	blue	35-48	S2	steel
AB-31775	anthracite	35-48	S2	steel
AB-31676	black	35-48	S3	steel

Low shoe uni6

Lace-up shoe. Upper material A-micro (microfiber); lining with silver ions: HACCP compatible; dimensionally stable, cushioned shaft edge and counter; shock-absorbing PU midsole; functional joint stabilizer; oil- and benzene-resistant outsole with continuous moisture groove and extremely slip-resistant ABEBA special profile. 02, FO, SRC; EN ISO 20347:2012



dpvlink 16662





Article	Color	Size	Category
Low shoe uni6			
AB-36781	black	35-48	02
AB-36780	white	35-48	02

Safety shoe

Safety shoe with lacing. Upper material functional leather with honeycomb design (water-repellent and scratch-resistant); lining with silver ions (moisture-absorbing); dimensionally stable, cushioned shaft edge and counter; PU midsole; oil- and fuel-resistant TPU outsole with flex zones, slip-resistant (SRC).

Variant safety shoe S1 and S2 additionally with steel toe cap



 **01** **02** **S1** **S2**    





dpvlink 16713 

Article	Color	Size	Category	Protective toe cap
Safety shoe				
AB-36760	white	35-48	01	none
AB-36761	black	35-48	02	none
AB-31760	white	35-48	S1	steel
AB-31761	black	35-48	S2	steel

Low shoe uni6

Low shoe. Upper material smooth leather; lining "on steam" (moisture-absorbing and breathable); dimensionally stable, cushioned shaft edge and counter; functional joint stabilizer; Soft-PU midsole; oil- and fuel-resistant TPU outsole with flex zones, slip-resistant (SRC).



 **02**   





dpvlink 16702 

Article	Color	Size	Category
Low shoe uni6			
AB-36750	white	35-48	02

Safety sandal

Sandal with velcro fastener; microfiber; moisture-absorbing and breathable microfiber lining; Soft-PU midsole; oil- and fuel-resistant TPU outsole with flex zones, slip-resistant (SRC). S2, SRC; EN ISO 20345:2011



 **S1**    







dpvlink 18472 

Article	Color	Size	Category	Protective toe cap
Safety sandal				
AB-31795	white	35-48	S1	steel

Safety loafer uni6

Safety loafer with elastic in the instep. Microfiber; breathable lining with silver ions; steel toe cap; slip-resistant TPU outsole; sanitized. S2, SRC; EN ISO 20345:2011



 **S2**      







dpvlink 18475 

Article	Color	Size	Category
Safety loafer uni6			
AB-31740	white	35-48	S2
AB-31741	black	35-48	S2

Safety shoe uni6

Safety shoe with lacing. Upper material A-micro (microfiber); lining with silver ions (moisture-absorbing); HACCP compatible; dimensionally stable, cushioned shaft edge and counter; steel toe cap; shock-absorbing PU midsole; functional joint stabilizer; oil- and benzene-resistant outsole with continuous moisture groove and extremely slip-resistant ABEBA special profile. S2, SRC; EN ISO 20345:2011



 **S2**      



dpvlink 16694 

Article	Color	Size	Category
Safety shoe uni6			
AB-31780	white	35-48	S2
AB-31781	black	35-48	S2

Low shoe air cushion

Lace-up shoe. Upper smooth leather, lining leather; extremely light, oil- and benzene-resistant PU air cushion outsole; slip-resistant (SRA).



 **02**  

dpvlink 1026 

Article	Color	Size	Category
Low shoe air cushion			
AB-32600	white	35-47	02
AB-32610	black	39-47	02

Loafer air cushion



Loafer; upper smooth leather, perforated; extremely light, oil- and benzine-resistant PU air cushion outsole, slip-resistant (SRA).



dpvlink 1034



Article	Color	Size	Category
Loafer air cushion			
AB-32310	black	39-47	01
AB-32300	white	35-47	01

Clog Classic



Safety clog with adjustable instep and fixed heel strap; Upper and top layer leather, lining grained leather; steel toe cap; extremely light, shock-absorbing, oil- and benzine-resistant mono PU outsole, slip-resistant (SRC).



dpvlink 322



Article	Color	Size	Category	Protective toe cap
Clog Classic				
AB-31000	white	36-46	SB	steel
AB-31010	black	36-46	SB	steel

Clog Classic



Safety clog with adjustable instep and fixed heel strap; upper A-micro, steel toe cap; extremely light, shock-absorbing, oil- and benzine-resistant mono PU outsole, slip-resistant (SRC).



dpvlink 15929



Article	Color	Size	Category	Protective toe cap
Clog Classic				
AB-31011	black	36-46	SB	steel

Clog x-light



Safety clog with adjustable and foldable heel strap. Elastic band over instep; upper smooth leather; lining with silver ions; steel toe cap; extremely light, shock-absorbing, oil- and benzine-resistant PU outsole, slip-resistant (SRC).



dpvlink 22620



Article	Color	Size	Category	Protective toe cap
Clog x-light				
AB-7131042	black	35-48	SB	steel
AB-7131041	white	35-48	SB	steel

Clog x-light



Safety clog with velcro fastener. Upper smooth leather; lining with silver ions; steel toe cap; extremely light, shock-absorbing, oil- and benzine-resistant PU outsole, slip-resistant (SRC).



dpvlink 22623



Article	Color	Size	Category	Protective toe cap
Clog x-light				
AB-7131035	black	35-48	SB	steel
AB-7131030	white	35-48	SB	steel

Sandal x-light



Sandal with breathable air-mesh textile inserts. Double velcro fastener; upper smooth leather; lining with silver ions; extremely light, oil- and benzine-resistant PU outsole, slip-resistant (SRC).

Variant safety shoe S1 additionally with steel toe cap



dpvlink 22626



Article	Color	Size	Category	Protective toe cap
Sandal x-light				
AB-7131136	black	35-48	01	none
AB-7131131	white	35-48	01	none
AB-7131036	black	35-48	S1	steel
AB-7131031	white	35-48	S1	steel

Loafer x-light

Safety loafer with elastic over instep. Upper smooth leather; lining with silver ions; extremely light, oil- and benzine-resistant PU outsole, slip-resistant (SRC).

Variant safety shoe S2 additionally with steel toe cap



dpvlink 22629

Article	Color	Size	Category	Protective toe cap
Loafer x-light				
AB-7131137	black	35-48	O2	none
AB-7131132	white	35-48	O2	none
AB-7131037	black	35-48	S2	steel
AB-7131032	white	35-48	S2	steel

Safety loafer x-light

Safety loafer, instep area with elastic band: upper microfiber, breathable, lining with silver ions; steel toe cap; extremely lightweight oil- and fuel-resistant PU outsole, slip-resistant, shock-absorbing. EN ISO 20345:2012, S2, SRC



dpvlink 22740

Article	Color	Size	Category	Protective toe cap
Safety loafer x-light				
AB-7131028	white	35-48	S2	steel
AB-7131029	black	35-48	S2	steel

Safety shoe x-light

Lace-up shoe with breathable air mesh textile inserts; upper smooth leather, lining with silver ions; extremely light, oil- and benzine-resistant PU outsole, shock-absorbing, slip-resistant (SRC).



dpvlink 23724

Article	Color	Size	Category	Protective toe cap
Safety shoe x-light				
AB-7131058	white	35-48	S1	steel

Low shoe x-light

Lace-up shoe with reflective stripes. Upper smooth leather; lining with silver ions; extremely light, oil- and benzine-resistant PU outsole, slip-resistant (SRC).

Variant safety shoe S2 and S3 additionally with steel toe cap



dpvlink 22636

Article	Color	Size	Category	Protective toe cap
Low shoe x-light				
AB-7131133	white	35-48	O2	none
AB-7131138	black	35-48	O2	none
AB-7131033	white	35-48	S2	steel
AB-7131038	black	35-48	S2	steel
AB-7131874	black	35-48	S3	steel

Low shoe x-light

Lace-up shoe. Upper microfiber, breathable, lining with silver ions; extremely light, oil- and benzine-resistant PU outsole, slip-resistant (SRC).

Variant safety shoe S2 additionally with steel toe cap



dpvlink 22743

Article	Color	Size	Category	Protective toe cap
Low shoe x-light				
AB-7131127	black	35-48	O2	none
AB-7131126	white	35-48	O2	none
AB-7131027	black	35-48	S2	steel
AB-7131026	white	35-48	S2	steel

Lace-up shoe x-light

Lace-up shoe; upper microfiber; breathable lining with silver ions; reflective stripes; PU outsole, slip-resistant (SRC).



dpvlink 25208

Article	Color	Size	Category	Protective toe cap
Lace-up shoe x-light				
AB-7131860	black / neon yellow	35-48	S3	steel

Safety shoe x-light



Safety lace-up shoe with breathable air mesh textile inserts; reflective stripes; upper smooth leather, lining with silver ions; steel toe cap; extremely light, oil- and benzene-resistant PU outsole, shock-absorbing, slip-resistant (SRC).



x-light



dpvlink 23722

Article	Color	Size	Category	Protective toe cap
Safety shoe x-light				
AB-7131056	black / red	35-48	S1	steel



Safety shoe x-light



Safety shoe with two velcro fasteners. Overcap with scratch-resistant coating; upper smooth leather; lining with silver ions; steel toe cap; extremely light oil- and fuel-resistant TPU outsole, shock-absorbing, slip-resistant (SRC).



x-light



dpvlink 23736

Article	Color	Size	Category	Protective toe cap
Safety shoe x-light				
AB-7131047	white	35-48	S2	steel



Clog ANATOM



Safety clog with adjustable instep, fixed adjustable heel strap. Upper breathable A-micro, washable at 30°C; antibacterial lining with silver ions; steel toe cap; two-layer PU outsole with protection from ankle twisting; flexzone, shock absorption, asymmetric heel and torsion waist made of TPU, slip-resistant (SRC)



anatom



dpvlink 8754

Article	Color	Size	Category	Protective toe cap
Clog ANATOM				
AB-32120	white	36-48	SB	steel
AB-32120-1	white	49-52	SB	steel
AB-32125	black	36-48	SB	steel
AB-32125-1	black	49-52	SB	steel



Safety sandal ANATOM



Safety sandal with double velcro fastener; reflector stripes. Upper breathable A-micro, washable at 30°C; moisture-absorbing, antibacterial special lining with silver threads; steel toe cap; two-layer PU outsole with protection from ankle twisting, flexzone, shock absorption, asymmetric heel and torsion waist made of TPU, slip-resistant (SRC).



anatom



dpvlink 13785

Article	Color	Size	Category	Protective toe cap
Safety sandal ANATOM				
AB-2616	white	36-48	S1	steel
AB-2616-1	white	49-50	S1	steel



Safety sandal ANATOM



Safety sandal with adjustable instep, reflector stripes. Upper suede/textile; steel toe cap; two-layer PU outsole with protection from ankle twisting, flexzone, shock absorption, asymmetric heel and torsion waist made of TPU, slip-resistant (SRC).



anatom



dpvlink 8766

Article	Color	Size	Category	Protective toe cap
Safety sandal ANATOM				
AB-32189	black	36-48	S1	steel
AB-32189-1	black	49-52	S1	steel



Safety shoe ANATOM



Safety lace-up shoe with scratch-resistant coating in the instep. Upper nubuck leather/textile; moisture-absorbing and antibacterial special lining; steel toe cap; two-layer PU outsole with protection from ankle twisting, flexzone, shock absorption, asymmetric heel and torsion waist made of TPU, slip-resistant (SRC).



anatom



dpvlink 8757

Article	Color	Size	Category	Protective toe cap
Safety shoe ANATOM				
AB-32147	black / marine	36-48	S1	steel
AB-32147-1	black / marine	49-50	S1	steel



Safety shoe ANATOM

Safety lace-up shoe with reflector stripes. Upper breathable Lorcica, washable at 30°C; moisture- absorbing, antibacterial special lining; steel toe cap, two-layer PU outsole with protection from ankle twisting, flexzone, shock absorption, asymmetric heel and torsion waist made of TPU, slip-resistant. S1, SRC; EN ISO 20345:2007



anatom



dpvlink 14455

Article	Color	Size	Category	Protective toe cap
Safety shoe ANATOM				
AB-2626-1	white	49-52	S1	steel
AB-2626	white	36-48	S1	steel

Safety lace-up shoe ANATOM

Safety lace-up shoe. Upper breathable Lorcica, washable at 30°C; moisture-absorbing, antibacterial special lining with silver threads; steel toe cap, two-layer PU outsole with protection from ankle twisting, flexzone, shock absorption, asymmetric heel and torsion waist made of TPU, slip-resistant. S2, SRC; EN ISO 20345:2011



anatom



dpvlink 10067

Article	Color	Size	Category	Protective toe cap
Safety lace-up shoe ANATOM				
AB-32131	white	36-48	S2	steel
AB-32136	black	36-48	S2	steel
AB-32131-1	white	49-50	S2	steel
AB-32136-1	black	49-50	S2	steel

Safety loafer ANATOM

Safety loafer with adjustable instep. Upper breathable A-micro, washable at 30°C; moisture-absorbing, antibacterial special lining with silver threads; steel toe cap, two-layer PU outsole with protection from ankle twisting, flexzone, shock absorption, asymmetric heel and torsion waist made of TPU, slip-resistant. S2 A, E, WRU, SRC; EN ISO 20345:2011



anatom



dpvlink 10064

Article	Color	Size	Category	Protective toe cap
Safety loafer ANATOM				
AB-32135	black	36-48	S2	steel
AB-32130	white	36-48	S2	steel
AB-32135-1	black	49-50	S2	steel
AB-32130-1	white	49-50	S2	steel

Safety shoe ANATOM

Safety shoe with double velcro fastener; microfiber white; lining with silver threads, washable at 30°C; HACCP conform; steel toe cap. S2, SRC; CE; EN ISO 20345:2011



anatom



dpvlink 17429

Article	Color	Size	Category	Protective toe cap
Safety shoe ANATOM				
AB-32140	white	36-48	S2	steel

Safety shoe ANATOM

Safety shoe with scratch-resistant coating in the toe and heel area, metal-free penetration-resistant midsole. Upper leather; reflector stripes; moisture-absorbing, antibacterial special lining; steel toe cap; two-layer PU outsole with protection from ankle twisting, flexzone, shock absorption, asymmetric heel and torsion waist made of TPU, slip-resistant. S3, SRC; EN ISO 20345: 2007



anatom



dpvlink 14427

Article	Color	Size	Category	Form
Safety shoe ANATOM				
AB-32256	black	36-48	S3	low shoe
AB-32268	black	36-48	S3	boot
AB-32256-1	black	49-52	S3	low shoe
AB-32268-1	black	49-52	S3	boot

Safety boots ANATOM

Safety boots with scratch-resistant coating in the toe and heel area; reflector stripes. Upper breathable A-micro, washable at 30°C; moisture absorbing, antibacterial, special lining; steel toe cap, two-layer PU outsole with protection from ankle twisting, flexzone, shock absorption, asymmetric heel and torsion waist made of TPU, slip-resistant. S2, SRC; EN ISO 20345: 2011



anatom



dpvlink 14399

Article	Color	Size	Category	Protective toe cap
Safety boots ANATOM				
AB-32172	white	36-48	S2	steel
AB-32172-1	white	49-50	S2	steel

Safety loafer StaticControl



Safety loafer. Upper Lorica; plastic toe cap; oil- and benzine-resistant special rubber outsole with flexzone, cross profile, lamellar profile and torsion waist, slip-resistant. S2, SRA; EN ISO 20345: 2007



dpvlink 953

Article	Color	Size	Category	Protective toe cap
Safety loafer StaticControl				
AB-31392	white	36-47	S2	plastic



Safety shoe ROAD



Safety shoe; upper suede; lining technical leather; increased breathability; composite toe cap; cap protection; metal-free penetration protection; antibacterial insole; PU/PU outsole; slip-resistant (SRC).



dpvlink 25433

Article	Color	Size	Category	Protective toe cap	Form
Safety shoe ROAD					
AB-5005847	green	38-48	S1P	composite	sandal
AB-5005848	green	38-48	S3	composite	low shoe
AB-5005849	green	38-48	S3	composite	boot
AB-5015847	black	38-48	S1P	composite	sandal
AB-5015848	black	38-48	S3	composite	low shoe
AB-5015849	black	38-48	S3	composite	boot



Safety shoe TRAX Automotive



Safety shoe; upper smooth leather; lining technical leather; increased breathability; composite toe cap; metal-free penetration protection; antibacterial insole; PU/PU outsole; slip-resistant (SRC).



dpvlink 25417

Article	Color	Size	Category	Protective toe cap	Form
Safety shoe TRAX Automotive					
AB-5005840	black	38-48	S1P	composite	sandal
AB-5005841	black	38-48	S3	composite	low shoe
AB-5005842	black	38-48	S3	composite	boot



Safety shoe TRAX



Safety shoe; upper suede; lining technical leather; increased breathability; composite toe cap; metal-free penetration protection; antibacterial insole; PU/PU outsole; slip-resistant (SRC).



dpvlink 25421

Article	Color	Size	Category	Protective toe cap	Form
Safety shoe TRAX					
AB-5015841	black	38-48	S3	composite	low shoe
AB-5015842	black	38-48	S3	composite	boot
AB-5025841	grey	38-48	S3	composite	low shoe
AB-5025842	grey	38-48	S3	composite	boot
AB-5045841	blue	38-48	S3	composite	low shoe
AB-5045842	blue	38-48	S3	composite	boot



Safety shoe BusinessMen

Safety lace-up shoe. Upper leather; lining microfiber; steel toe cap; oil- and benzine-resistant rubber outsole, slip-resistant (SRA).



**BUSINESS
MEN**



[dpvlink 13801](#)

Article	Color	Size	Category	Protective toe cap	
Safety shoe BusinessMen					
AB-33240	black	36-48	S2	steel	

Safety shoe BusinessMen

Safety lace-up shoe. Upper leather; lining microfiber; steel toe cap; oil- and benzine-resistant rubber outsole, slip-resistant (SRA).



**BUSINESS
MEN**



[dpvlink 10062](#)

Article	Color	Size	Category	Protective toe cap	
Safety shoe BusinessMen					
AB-33230	black	36-48	S2	steel	

Men's lace-up shoe BusinessMen

Men's lace-up shoe. Upper cowhide, breathable and moisture-absorbing microfiber lining, leather top layer; abrasion-resistant, oil- and benzine-resistant TPU outsole, slip-resistant (SRA).



**BUSINESS
MEN**



[dpvlink 14374](#)

Article	Color	Size	Category	
Men's lace-up shoe BusinessMen				
AB-32450	black	40-47	01	

Safety sandal TRAX

NEU 

Safety sandal; smooth leather upper; technical fabric lining; composite toe cap; metal-free penetration protection; PU/PU outsole; slip-resistant SRC.



[dpvlink 28415](#)

Article	Color	Size	Category	Protective toe cap	Form	
Safety sandal TRAX						
AB-5010860	black	35-51	S3	composite	sandal	
AB-5012860	white	35-51	S3	composite	sandal	

Safety shoes BASIC BLACK

NEU 

Safety shoes; microfiber upper; technical fabric lining; metal-free penetration protection; composite toe cap; PU/PU outsole, oil-, acid- and petrol-resistant; antistatic; EN ISO 20345 SRC.



[dpvlink 28419](#)

Article	Color	Size	Category	Upper	Form	
Safety shoes BASIC BLACK						
AB-252430	black	36-47	S1P	microfiber	sandal	
AB-252375	black	36-47	S1P	microfiber / texture	low shoe	
AB-252383	black	36-47	S1P	suede / microfiber	low shoe	

Special shoes

Special clog

Special clog made of autoclavable, sterilizable special material with foldable heel strap; comfortable fit; **autoclavable at 135° C**, washable at 60° C, suitable for cleanroom; outsole slip-resistant outsole (SRC).



dpvlink 10057

Article	Color	Size	Category
Special clog			
AB-39600	white	35-46	OB
AB-39630	orange	36-46	OB
AB-39620	green	35-46	OB
AB-39610	blue	35-46	OB

Cleanroom loafer

Cleanroom loafer with integrated footbed. Upper A-micro, breathable; elastic band over instep; decontaminable up to 30 times; washable up to 60°C; extremely light, oil- and benzine-resistant PU air cushion outsole, slip-resistant (SRA).



dpvlink 8771

Article	Color	Size	Category
Cleanroom loafer			
AB-32370	white	35-47	01

Cleanroom boots

Cleanroom boots. Upper microfiber; washable at 30°C (material must be checked, because it can lose its function); oil- and benzine-resistant PU outsole, slip-resistant (SRA).

Minimum order quantity required!



dpvlink 14481

Article	Color	Size	Category
Cleanroom boots			
AB-3620	white	35-47	OB

Cleanroom shoe with gaiter

Cleanroom shoe with gaiter. Upper leather, perforated; gaiter cleanroom textile as requested; oil- and benzine-resistant PU outsole, slip-resistant (SRA).

Minimum order quantity required !



dpvlink 14483

Article	Color	Size
Cleanroom shoe with gaiter		
AB-1144	white	35-48

Insoles

Insole für models Reflexor® 



- air bubble insole
- stimulation of the foot reflexzones
- stimulates blood-circulation
- orthopedic cushioning
- leather-covered
- comfortable
- flat and smooth

dpvlink 16006

Article	Type	Size	
Insole für models Reflexor®			
AB-3565	Massage Active	36-42	
AB-3566	Massage Active	40-46	
AB-3572	Replacement insole ESD Reflexor XXL	36-43	
AB-3567	Comfort white	36-42	
AB-3569	Comfort white	40-46	
AB-3568	Comfort anthracite	36-42	
AB-3570	Replacement insole ESD Reflexor, anthracite	40-46	

Insole for models StaticControl 



- Instant shock absorption
- Even pressure distribution over the whole surface
- Air circulation under the entire foot surface
- Support of the forefoot

dpvlink 16002

Article	Type	Size	
Insole for models StaticControl			
AB-3553	acc Wave StaticControl	36-47	

ESD Active Comfort insole 



- ESD Active Comfort insole
- anti-odor activated carbon
- additional support of the metatarsus
- antibacterial
- moisture-release outward
- very lightweight

dpvlink 22746

Article	Type	Size	
ESD Active Comfort insole			
AB-351920	for Crawler Aluminium / Steel safety shoes	36-48	
AB-352020	for Crawler aluminum safety shoes open	36-48	
AB-352710	for Easy professional shoes	35-48	
AB-352320	for closed Anatom shoes	36-52	
AB-352420	for open Anatom shoes	36-52	
AB-352510	for uni6 occupational shoes	35-48	
AB-352520	for uni6 safety shoes	35-48	
AB-352610	for Dynamic safety shoes	35-48	
AB-351710	for open x-light professional shoes	35-48	
AB-351610	for closed x-light professional shoes	35-48	
AB-351720	for open x-light safety shoes	35-48	
AB-351620	for closed x-light safety shoes	35-48	

ESD Active MedFit insole for Dynamic flow models 



dpvlink 24582

Article	Type	Size	
ESD Active MedFit insole for Dynamic flow models			
AB-352630	for Dynamic flow professional shoes	35-48	

EPApro®

EPApro® ESD Personal Grounding Control System

The innovative EPApro® complete solution for your ESD-protected work areas combines user-friendly precision hardware with a future-oriented software solution for measuring your ESD safety equipment as well as convenient and standard-compliant documentation and central management of the data collected. Multifunctional EPApro® interfaces and control outputs enable simple integration into your company's existing infrastructure.

dpvlink: 21010 

Advantages of the EPApro® ESD Personnel Tester 1000

- Simple and intuitive operation
- Data logging in compliance with GDPR
- Paperless and low administration
- Integrated Multi RFID reader
- Multilingual
- Only one central server required
- Employee groups
- Several testers can be networked
- Centralized recording and archiving of measured data
- Simple import of employee master data
- For use with access control systems

Systems against Electrostatics



Today, the requirements for safety shoes are very high and manifold. J alas® safety shoes are ideal for the use in EPA zones as they are optimally adapted to the demands in electronics manufacturing. They are comfortable to wear, lightweight and easy to care. Shoes with antistatic properties ensure also a reliable ESD protection. Additionally many J alas® models have a shock-absorbing and breathable insole. In compliance with the ESD standard DIN EN 61340-5-1 ⚡



ESD approved shoes
in accordance with EN 61340

01 Work shoes 01
in accordance with EN ISO 20347

02 Work shoes 02
in accordance with EN ISO 20347

S1 Safety shoes S1
in accordance with EN ISO 20345

S1P Safety shoes S1P
in accordance with EN ISO 20345

S2 Safety shoes S2
in accordance with EN ISO 20345

S3 Safety shoes S3
in accordance with EN ISO 20345

STEEL Steel toe cap

ALU Aluminum toe cap

METAL FREE Metal-free toe cap

SRA Slip resistance SRA
in accordance with EN 13287

SRB Slip resistance SRB
in accordance with EN 13287

SRC Slip resistance SRC
in accordance with EN 13287

METAL FREE Penetration protection metal-free

Very lightweight shoe

Overcap
Toe wear protection

Exchangeable insole

DGUV standard 112-191
Suitable for orthopedic insoles in accordance with DGUV standard 112-191

BOA® BOA® closure system
for an easy fitting of the shoe

E Ergothon
(prevents back and foot pain)

Stabilizer
(Protection against twisting one's ankle)

Water-repellent

Professional and safety footwear

Sandal CARE



Sandale CARE with velcro fastener; adjustable heel and instep straps; shock-absorbing zone made of Poron® XRD®; oil-resistant PU outsole, antistatic. EN ISO 20347 01 SRC



dpvlink 13497

Article	Color	Size	Category
Sandal CARE			
JA-5042	black	36-47	01



Low shoe SPOC



Sporty low shoe; upper leather; polyester lining; shock-absorbing zone made of Poron® XRD®; oil-resistant EVA/rubber outsole, antistatic. EN ISO 20347 02 SRC



dpvlink 21361

Article	Color	Size	Category
Low shoe SPOC			
JA-5342	black	35-48	02
JA-5352	black	35-48	02



Low shoe SPOC



Light low shoe with lace fastener; upper textile; polyester lining; shock-absorbing zone made of Poron® XRD®; EVA/rubber outsole, slip-resistant. EN ISO 20347 01 SRC



dpvlink 26097

Article	Color	Size	Category
Low shoe SPOC			
JA-5392	black	35-48	01
JA-5492	white	35-48	01



Low shoe SPOC Boa®



Light low shoe with quick closure BOA®; upper textile; polyester lining; shock-absorbing zone made of Poron® XRD®; EVA/rubber outsole, slip-resistant. EN ISO 20347 O1 SRC



dpvlink 23435

Article	Color	Size	Category
Low shoe SPOC Boa®			
JA-5362	black / orange	35-48	O1
JA-5462	white	35-48	O1
JA-5382	black	35-48	O1



Safety shoe TEMPUS 5608



Sporty safety shoe; upper made of microfiber and textile; steel toe cap; shock-absorbing zone made of Poron® XRD®; penetration protection made of plasma-treated composite/textile; oil-resistant rubber outsole, antistatic. EN ISO 20345 S1P SRC



dpvlink 27295

Article	Color	Size	Category
Safety shoe TEMPUS 5608			
JA-5608	white	35-48	S1P



Safety shoe TEMPUS 5668



Lightweight safety shoe; upper made of microfiber and textile; steel toe cap; shock-absorbing zone made of Poron® XRD®; penetration protection made of plasma-treated composite/textile; oil-resistant rubber outsole, antistatic. EN ISO 20345 S1P SRC



dpvlink 27297

Article	Color	Size	Category
Safety shoe TEMPUS 5668			
JA-5668	black / green	35-48	S1P



Safety shoe TEMPUS 5618 / 5628



Lightweight safety shoe; steel toe cap; shock-absorbing zone made of Poron® XRD®; EVA midsole, slip-resistant. EN ISO 20345 S1P SRC



dpvlink 27299

Article	Color	Size	Category
Safety shoe TEMPUS 5618 / 5628			
JA-5618	black	35-48	S1P
JA-5628	black / pink	35-42	S1P



Safety shoe TIO 2028



Safety shoe; upper made of microfiber and textile with CPU coating; aluminum toe cap; shock-absorbing zone made of Poron® XRD®; penetration protection made of plasma-treated composite/textile; RPU outsole, antistatic. EN ISO 20345 S3 SRC



dpvlink 27371

Article	Color	Size	Category
Safety shoe TIO 2028			
JA-2028	black / blue	35-48	S3



Safety shoe TIO 2058



Breathable safety shoe; upper made of microfiber and textile with CPU coating; aluminum toe cap; shock-absorbing zone made of Poron® XRD®; penetration protection made of plasma-treated composite/textile; RPU outsole, antistatic. EN ISO 20345 S1P SRC



dpvlink 27369

Article	Color	Size	Category
Safety shoe TIO 2058			
JA-2058	black / yellow	35-48	S1



RESPIRO



The safety shoes of the Jalas **Respiro** series are equipped with a unique, three-layered IQ TEX[®] laminate. The especially **breathable upper surface** and **ventilated shock absorption material** in the insole keep your feet dry. The temperature in the shoe is **regulated**. So there will be no sweat or unpleasant odors.

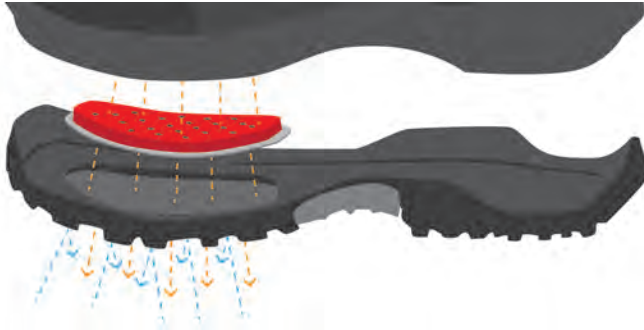

Safety sandal 3800R / 3820R RESPIRO



Breathable safety sandal with velcro fastener; ultra-high air permeability, ventilation holes, padded shaft edges; shock-absorbing zone made of Poron[®] XRD[®]; oil-resistant TPU outsole, antistatic.

3800R RESPIRO JA-3800R: upper microfiber; EN ISO 20345 S1 SRB

3820R RESPIRO JA-3820R: upper nubuck/textile; EN ISO 20345 S1 SRB



RESPIRO



dpvlink 20142

Article	Color	Size	Category	Closure	Upper
Safety sandal 3800R / 3820R RESPIRO					
JA-3800R	black / blue	36-47	S1	velcro fastener	microfiber
JA-3820R	black / blue	36-47	S1	velcro fastener	nubuck / textile

Safety sandal 3510R RESPIRO



Sporty safety sandal; upper PU-coated leather/textile; ultra-high air permeability; aluminum toe cap; shock-absorbing zone made of Poron[®] XRD[®]; oil-resistant TPU outsole, antistatic. EN ISO 20345 S1 SRB



RESPIRO



dpvlink 20148

Article	Color	Size	Category
Safety sandal 3510R RESPIRO			
JA-3510R	white	36-47	S1

Safety shoe 3700R RESPIRO



Sporty safety shoe; upper PU-coated leather/textile; ultra-high air permeability; aluminum toe cap; shock-absorbing zone made of Poron[®] XRD[®]; oil-resistant TPU outsole, antistatic. EN ISO 20345 S2 SRB



RESPIRO



dpvlink 20144

Article	Color	Size	Category
Safety shoe 3700R RESPIRO			
JA-3700R	black / blue	36-47	S2



POWER TO MOVE ZENIT EVO SELECTION

Zenit EVO insole

Multiple layers for ultimate ergonomics and comfort

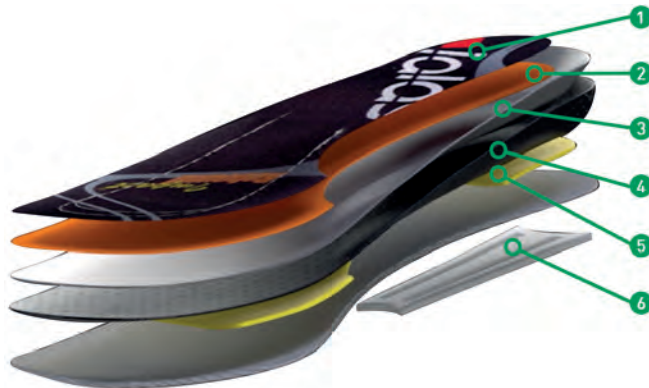

1. Textile layer
2. **Neo Foam layer** - protects the entire foot area from impacts
3. **Soft EVA basic layer** - provides structures, stability and comfort
4. **Hard EVA layer** - maintains the shape and functionality of the insole, provides support and stability
5. **PORON® XRD™** - offers unique shock-absorbing properties
6. **Stabilizing element** - improves the stability of the shoe

Safety shoe ZENIT EVO Boa®

Safety shoe, textile upper; with Boa® quick-release fastener; seamlessly finished; polyester/polyamide lining; aluminium toe cap; flexible, ultra-thin penetration protection; double shock-absorbing zones made of Poron XRD. EN ISO 20345 S1P SRC



dpvlink 21358

Article	Color	Size	Category	Closure
Safety shoe ZENIT EVO Boa®				
JA-7158	blue / black	35-48	S1P	Boa® / quick-release fastener
JA-7108	black / red	35-48	S1P	Boa® / quick-release fastener

Safety shoe ZENIT EVO

Safety shoe, textile upper; seamlessly finished; polyester/polyamide lining; aluminium toe cap; double shock-absorbing zones made of Poron XRD. EN ISO 20345 S1 / S1P SRC



dpvlink 21354

Article	Color	Size	Category	Closure
Safety shoe ZENIT EVO				
JA-7128	grey / black	35-48	S1P	lace fastening
JA-7100	black / red	35-48	S1	lace fastening

Safety shoe 1635 / 1645 / 1655 E-Sport

Comfortable safety shoe; upper leather/textile; aluminum toe cap; shock absorption zone of Ergothan, oil-resistant PU outsole, antistatic. EN ISO 20345 S1 / S1P SRC



dpvlink 25263

Article	Color	Size	Category	Form
Safety shoe 1635 / 1645 / 1655 E-Sport				
JA-1635	black / blue	36-47	S1	low shoe
JA-1645	black / blue	36-47	S1P	low shoe
JA-1655	black / blue	36-47	S1P	boot

Safety sandal 1605 E-Sport

Safety sandal, upper PU-coated leather with velcro fastener; aluminium toe cap; metal-free penetration protection; shock-absorbing, oil-resistant PU outsole; antistatic. EN ISO 20345 S1P SRC



dpvlink 18481

Article	Color	Size	Category
Safety sandal 1605 E-Sport			
JA-1605	black / grey	36-47	S1P

Systems against Electrostatics

Safety shoe 1615 E-Sport



ESD safety shoe; upper PU-coated leather; aluminium toe cap; metal-free penetration protection; shock-absorbing, oil-resistant PU outsole; antistatic. EN ISO 20345 S3 SRC



dpvlink 18482

Article	Color	Size	Category
JA-1615	black / red	36-47	S3

Safety boot E-Sport



Safety boot, upper PU-coated leather; aluminium toe cap; metal-free penetration protection; shock-absorbing, oil-resistant PU outsole; antistatic. EN ISO 20345 S3 HI CI SRC



dpvlink 26618

Article	Color	Size	Category
JA-1625	black / red	36-47	S3

Safety shoe BLACK



Classic safety shoe; upper leather; aluminum toe cap; metal-free penetration protection; shock-absorbing zone made of Poron® XRD®; oil-resistant rubber outsole, antistatic. EN ISO 20345 S3 SRB



dpvlink 20150

Article	Color	Size	Category
JA-1335	black	36-47	S3

Safety shoe EXALTER



Sporty safety shoe; aluminum toe cap; double shock absorption zone of Poron XRD. EN ISO 20345 S1P / S3 SRC



dpvlink 25204

Article	Color	Size	Category	Form
Safety shoe EXALTER				
JA-9915	black / green	34-47	S1P	low shoe
JA-9955	black / red	34-47	S3	low shoe
JA-9975	black / red	34-47	S3	boot

Safety shoe EXALTER Boa®



Comfortable safety shoe with quick-release fastener BOA®; upper microfiber/textile; polyester lining; aluminum toe cap; metal-free penetration protection; double shock-absorbing zones made of Poron® XRD®; EVA/rubber outsole, slip-resistant. JA-9925 and JA-9945 EN ISO 20345 S1P SRC
JA-9965 and JA-9985 additionally water-repellent EN ISO 20345 S3 SRC



dpvlink 23448

Article	Color	Size	Category	Form
Safety shoe EXALTER Boa®				
JA-9965	black / red	34-47	S3	low shoe
JA-9925	black / green	34-47	S1P	low shoe
JA-9985	black / red	34-47	S3	boot
JA-9945	black / green	34-47	S1P	boot

Safety shoe ZENIT - EASYROLL

Safety shoe with innovative shock absorption system; BOA closure system; aluminum toe cap; ProNose overcap; shock absorption zones made of Poron XRD and merino wool interlayer; shock-absorbent RPU outsole with stabilizer waist; slip resistant. EN ISO 20345 S1P S3 SRC



dpvlink 18071

Article	Color	Size	Category	Form
Safety shoe ZENIT - EASYROLL				
JA-1708	black / red	36-47	S1P	sandal
JA-1738	black / red	36-47	S3	low shoe

Safety sandal BIO

Safety sandal with with velcro fastener; upper microfiber/textile; composite toe cap; metal-free penetration protection; ProNose toe cap wear protection; shock-absorbing zone made of Poron XRD; oil-resistant PU outsole, antistatic. EN ISO 20345 S1P SRC



dpvlink 16087

Article	Color	Size	Category
Safety sandal BIO			
JA-6418	black	36-47	S1P

Safety shoe EKO

Comfortable safety shoe; upper microfiber/textile; composite toe cap; metal-free penetration protection; ProNose toe cap wear protection; shock-absorbing zone made of Poron XRD; oil-resistant PU outsole, antistatic. EN ISO 20345 S3 SRC



dpvlink 13494

Article	Color	Size	Category
Safety shoe EKO			
JA-6468	black	36-47	S3

Safety sandal Pro 3100

Light safety sandal with velcro fastener; upper PU-coated leather; aluminum toe cap; shock-absorbing zone made of Poron XRD; oil-resistant TPU outsole, antistatic. EN ISO 20345 S1 SRB



dpvlink 16283

Article	Color	Size	Category
Safety sandal Pro 3100			
JA-3100	black / yellow	36-47	S1

Safety shoe Pro 3110

Light safety shoe; upper leather/textile; aluminum toe cap; shock-absorbing zone made of Poron XRD; oil-resistant rubber outsole, antistatic. EN ISO 20345 S2 SRB



dpvlink 16278

Article	Color	Size	Category
Safety shoe Pro 3110			
JA-3110	black / yellow	36-47	S2

Safety sandal ZENIT 3020

Safety sandal with velcro fastener; padded leg edge of Memory Foam; aluminum toe cap; shock-absorbing zone made of Poron XRD; oil-resistant RPU outsole, antistatic. EN ISO 20345 S1 SRC



dpvlink 14515

Article	Color	Size	Category
Safety sandal ZENIT 3020			
JA-3020	black / red	36-47	S1

Safety shoe ZENIT 3030



Safety shoe; upper nubuck/textile; padded leg edge of Memory Foam; aluminum toe cap; shock-absorbing zone made of Poron® XRD®; oil-resistant RPU outsole, antistatic. EN ISO 20345 S2 SRC



dpvlink 14516

Article	Color	Size	Category
JA-3030	Safety shoe ZENIT 3030 black / red	36-47	S2

Men's shoes VIP



Elegant men's shoe made of leather; shock-absorbing zone made of Poron® XRD®; oil-resistant PU outsole, antistatic. EN ISO 20347 O2 SRA



dpvlink 10110

Article	Color	Size	Category	Form
JA-2112	Men's shoes VIP black	39-47	O2	low shoe
JA-2142	brown	39-47	O2	low shoe

Insoles

FX2 Pro insole ESD



suitable for all J alas shoes and safety shoes



- breathable
- double shock-absorption due to Poron® XRD® under forefoot and heel
- textile with soft EVA material
- ESD compliant ⚠

dpvlink 15575

Article	Type	Size
JA-8102	FX2 Pro	35-48

FX3 Supreme insole ESD



suitable for all J alas low and safety shoes



- very comfortable
- optimized shock absorption
- breathable
- ESD compliant ⚠

dpvlink 24966

Article	Type	Size
JA-8303	FX 3 Supreme	34-47

FX2 Supreme ESD



suitable for all J alas low and safety shoes



- breathable
- very comfortable
- double shock-absorption due to Poron® XRD® under forefoot and heel
- merino midsole
- ESD compliant ⚠

dpvlink 25715

Article	Type	Size
JA-8202	FX 2 Supreme	35-50

Anatomic insole ESD



suitable for all J alas low and safety shoes



- double shock absorption zone of Poron® XRD®
- distinct heel cup
- perforated forefoot
- ESD-compliant ⚠

dpvlink 16947

Article	Type	Size	Color
Anatomic insole ESD			
JA-8709H	for high arch	34-50	blue
JA-8710M	for normal arch	34-50	green
JA-8711L	for low arch	34-50	orange



Having an experience of more than 70 years, Sievi is a specialist for safety shoes, also in the ESD sector, and the largest shoe manufacturer in North Europe. Sievi's requirements for its professional and safety footwear are characterized by a very high level of occupational safety, fitting and wearing comfort. A continuous development of high-quality work shoes, the application of the latest technology and the use of the best materials and properties are also part of Sievi's philosophy.

In compliance with the ESD standard DIN EN 61340-5-1 



 **ESD approved shoes**
in accordance with EN 61340

 **Work shoes OB**
in accordance with EN ISO 20347

 **Work shoes O1**
in accordance with EN ISO 20347

 **Work shoes O2**
in accordance with EN ISO 20347

 **Safety shoes SB**
in accordance with EN ISO 20345

 **Safety shoes S1**
in accordance with EN ISO 20345

 **Safety shoes S1P**
in accordance with EN ISO 20345

 **Safety shoes S2**
in accordance with EN ISO 20345

 **Safety shoes S3**
in accordance with EN ISO 20345

 **Safety shoes S3L according to EN ISO 20345:2022**

 **Steel toe cap**

 **Aluminum toe cap**

 **Metal-free toe cap**

 **Slip resistance SR according to EN 13287**

 **Slip resistance SRC**
in accordance with EN 13287

 **Penetration protection metal-free**

 **100% metal-free shoe**

 **Exchangeable insole**

 **DGVU standard 112-191**
Suitable for orthopedic insoles in accordance with DGVU standard 112-191

 **BOA® closure system**
for an easy fitting of the shoe

 **Water-repellent**

 **Laufsohle aus PU/Gummi**

 **XL last**

 **DUAL insole**

 **Adapts to the foot, cushions and protects the joint**

 **DryStep insoles**
(allow moisture to escape)

 **3D-dry lining**
(wicks moisture away from the foot)

 **Microfiber sole material**
(excellent shock absorption and elasticity event at freeze)

 **SieviBalance**
(safer step and more impact resistance)

 **Flexible heel element**
in the sole for maximal shock absorption and excellent comfort with every step, made of TPU Infinergy®

 **Penetration protection steel**

Slippers, sandals, clogs

Sandal Ion Black 2

Comfortable sandal with velcro fastener; upper nubuck; 3D-dry® lining; machine washable (at 40°C) insole; shock-absorbing FlexStep® PU outsole, oil- and chemical-resistant, antistatic. EN ISO 20347 OB A E FO



dpvlink 21148

Article	Color	Size	Category
Sandal Ion Black 2			
SI-12156	black	36-42	OB



Slipper Art 2 / Rom 2

Comfortable slipper with velcro fastener, partly with adjustable heel strap, upper nubuck; 3D-dry® lining; machine washable (at 40°C) insole; shock-absorbing FlexStep® PU outsole, oil- and chemical-resistant, antistatic. EN ISO 20347 OB A E FO



dpvlink 21150

Article	Color	Size	Category	Form	Closure
Slipper Art 2 / Rom 2					
SI-12146	black	39-47	OB	slipper	velcro fastener
SI-12157	black	39-47	OB	sandal	velcro fastener



Sandal Active

Comfortable sandal with heel and instep straps adjustable by velcro fastener; upper microfiber (washable); 3D-dry® lining; shock-absorbing FlexStep®-PU outsole, oil- and chemical-resistant, antistatic. EN ISO 20347 OB SRC A E FO



dpvlink 21156

Article	Color	Size	Category
Sandal Active			
SI-12225	black	35-47	OB



Clog File



Clog File black of resistant PU leather; Clog File White upper of microfiber withstanding frequent washing; adjustable heel strap with elastic, higher heel; exchangeable Sievi comfort insole; shock-absorbing FlexStep® PU outsole, oil- and chemical-resistant, antistatic. EN ISO 20347:0B SRC A E FO



dpvlink 17183

Article	Color	Size	Category
Clog File			
SI-12327M	black	35-47	OB
SI-12327W	white	35-47	OB



Clog Monica 2



Clog with adjustable heel strap; upper PU-coated, breathable leather; 3D-dry® lining; PU outsole, oil- and chemical-resistant, antistatic. EN ISO 20347 OB SRC A E FO



dpvlink 25970

Article	Color	Size	Category	Form
Clog Monica 2				
SI-12203	black	35-43	OB	clog



Professional and safety footwear

Safety clog Riff



Stylish safety clog with heel strap, upper PU-coated leather or microfiber; steel toe cap; shock-absorbing FlexStep® PU outsole, oil- and chemical-resistant, antistatic. EN ISO 20345 SB SRC A E FO



dpvlink 15470

Article	Color	Size	Upper	Category
Safety clog Riff				
SI-52933M	black	35-48	leather	SB
SI-52933W	white	35-47	microfiber	SB



Low shoe Ballerina 2



Low show with velcro fastener; upper grain leather; 3D-dry® lining; PU outsole; counter of leather fiber; oil- and chemical-resistant, antistatic. EN ISO 20347 01 SRC FO



dpvlink 25974

Article	Color	Size	Category	Form
Low shoe Ballerina 2				
SI-12202	black	35-43	01	sandal



Low shoe Fly



Sporty low shoe with breathable textile upper; 3D-dry lining; elastic FlexEnergy element; shock-absorbing FlexStep®-PU outsole, oil- and chemical-resistant, antistatic. EN ISO 20347 02 SRC FO



dpvlink 22442

Article	Color	Size	Category	Closure
Low shoe Fly				
SI-12192	black / white	35-47	02	lace fastening
SI-12190	blue	35-47	02	Boa® / quick-release fastener
SI-12196	black	35-47	02	lace fastening



Men's lace-up shoe Street



Stylish men's lace-up shoe, upper grained leather; 3D-dry lining; shock-absorbing Flex-Step outsole; very comfortable to wear due Comfort insole oil- and chemical-resistant, antistatic; EN ISO 20347 01 SRC FO



dpvlink 19492

Article	Color	Size	Category
Men's lace-up shoe Street			
SI-12171	black	39-48	01



Men's shoe Mark



Men's shoe, upper grained leather; shock-absorbing FlexStep® PU outsole; oil- and chemical-resistant, antistatic.



dpvlink 15460

Article	Color	Size	Category
SI-12010	Men's shoe Mark black	40-48	OB



Safety shoe Racer EcoTech



Safety shoe; upper textile; aluminum toe protection; penetration protection; 3D dry® lining; outsole made of PU/RU and FlexEnergy, resistant to oil and chemicals, antistatic. EN ISO 20345 S3L SR



dpvlink 28154

Article	Color	Size	Category
SI-52366	Safety shoe Racer EcoTech black / green	35-48	S3L



Safety shoe Lazer Roller+ S3



Safety shoe; upper microfiber; metal-free toe protection; steel penetration protection; 3D dry® lining; two-layer outsole made of PU/RU and FlexEnergy, resistant to oil and chemicals, antistatic. EN ISO 20345 S3 SR



dpvlink 28152

Article	Color	Size	Category
SI-52311	Safety shoe Lazer Roller+ S3 black / yellow	35-48	S3



Safety shoe Planar



Safety shoes of the new generation, steel toe cap and penetration protection; very robust outsole for a good grip even on slippery surfaces, 3D-dry lining; oil- and chemical-resistant, water-repellent. EN ISO 20345 S3 SRC



dpvlink 19430

Article	Color	Size	Category	Form
Safety shoe Planar				
SI-52173	black / white	35-48	S3	low shoe
SI-52135	black / white	35-48	S3	boot



Safety shoe Terrain



Modern safety shoe; upper nubuck; aluminium toe cap; steel penetration protection; 3D-dry® lining; elastic Sievi FlexEnergy element for maximal shock absorption; one-layer PU outsole with shock-absorbing FlexStep® interlayer, oil- and chemical-resistant, antistatic. EN ISO 20345 S3 SRC



dpvlink 22436

Article	Color	Size	Category	Form
Safety shoe Terrain				
SI-52357	brown	39-47	S3	low shoe



Safety shoe Rival



Sporty safety shoe; upper PU-coated split leather; aluminum toe cap; 3D-dry lining; suitable for orthopedic insoles; shock-absorbing FlexStep® PU outsole, oil- and chemical-resistant, antistatic; EN ISO 20345 S2 SRC



dpvlink 17222

Article	Color	Size	Category	Protective toe cap
Safety shoe Rival				
SI-52190	black / grey	36-47	S2	aluminum



Safety shoe Racer Free Roller



Safety shoe; upper PU-coated leather/textile; breathable network structure; BOA® quick closure; aluminum toe cap; steel penetration protection; 3D-dry lining; elastic FlexEnergy element for maximal shock absorption; double-layer ActionPro outsole with shock-absorbing FlexStep® interlayer, oil- and chemical-resistant, antistatic. EN ISO 20345 S1P SRC



dpvlink 22434

Article	Color	Size	Category	Protective toe cap
Safety shoe Racer Free Roller				
SI-52363	black / orange	34-47	S1P	aluminum

Safety shoe TR Racer



Sporty safety shoe; upper PU-coated leather/textile; aluminum toe cap; 3D-dry lining; elastic FlexEnergy element for maximal shock absorption; double-layer ActionPro outsole with shock-absorbing FlexStep® interlayer, oil- and chemical-resistant, antistatic. EN ISO 20345 S3 SRC



dpvlink 21043

Article	Color	Size	Category	Closure	Protective toe
Safety shoe TR Racer					
SI-52343	black / orange	34-48	S3	Boa®	aluminum
SI-52342	black / orange	35-48	S2	lace fastening	aluminum

Safety shoe Zone 2+



Safety shoe; upper PU-coated leather and microfiber; metal-free; plastic toe cap; composite/textile penetration protection; 3D-dry lining; two-layered PU/TPU outsole with shock-absorbing FlexStep® interlayer, oil- and chemical-resistant, antistatic. EN ISO 20345 S3 SRC



dpvlink 25888

Article	Color	Size	Category
Safety shoe Zone 2+			
SI-52102	black	36-47	S3

Safety sandal SieviAir Galaxy



Safety sandal with composite toe cap, upper microfiber; shoe tips with brushed PU coated leather; 3D-dry lining; shock-absorbing FlexStep® outsole, oil- and chemical-resistant, antistatic; EN ISO 20345 S1 SRC



dpvlink 19488

Article	Color	Size	Category	Form	Standard width
Safety sandal SieviAir Galaxy					
SI-52520	black / orange	36-38	S1	sandal	11
SI-52520-XL	black / orange	39-47	S1	sandal	12

Safety sandal SieviAir Roller



Safety sandal with BOA® quick-release fastener, plastic toe cap, sole with penetration protection, upper polished split leather; 3D-dry lining; shock-absorbing FlexStep® outsole, oil- and chemical-resistant, antistatic; EN ISO 20345: S1 / S1P SRC



dpvlink 20063

Article	Color	Size	Category	Standard width
Safety sandal SieviAir Roller				
SI-52524	black / turquoise	36-38	S1	11
SI-52524-XL	black / turquoise	39-47	S1	12
SI-52523	black / orange	36-38	S1P	11
SI-52523-XL	black / orange	39-47	S1P	12

Safety shoe SieviAir R2



Safety shoe, upper microfiber; aluminum toe cap; 3D-dry lining; elastic FlexEnergy element; breathable SieviAir® PU outsole, oil- and chemical-resistant, antistatic. EN ISO 20345:S1 SRC



dpvlink 23310

Article	Color	Size	Category	Form
Safety shoe SieviAir R2				
SI-52378	black / green	35-48	S1	low shoe

Safety shoe SieviAir R3 / R5H / R4

Safety shoes, upper microfiber; aluminum toe cap, steel penetration protection; 3D-dry lining; elastic FlexEnergy element; breathable SieviAir® PU outsole, oil- and chemical-resistant, antistatic; EN ISO 20345:S1P S3 SRC



dpvlink 23313

Article	Color	Size	Category	Form
Safety shoe SieviAir R3 / R5H / R4				
SI-52375	black / green	35-48	S3	low shoe
SI-52385	black / green	35-48	S1P	sandal
SI-52371	black / green	35-48	S1P	boot

Safety shoe Roller+

Safety shoe with BOA® quick-release closure system; plastic toe cap, upper PU-coated leather, partly microfiber, 3D-dry lining; steel penetration protection; PU/TPU outsole, Roller XL+ S3 with PU outsole, with shock-absorbing FlexStep® mid-layer, oil- and chemical-resistant, antistatic; EN ISO 20345 S3 SRC



dpvlink 17197

Article	Color	Size	Category	Form	Standard width
Safety shoe Roller+					
SI-52156-113	black / yellow	39-47	S3	low shoe	11
SI-52156-153	black / orange	39-47	S3	low shoe	12
SI-52184	black / pink	35-42	S3	low shoe	11
SI-52157	black / orange	39-47	S3	boot	12
SI-52185	black / yellow	36-42	S3	boot	11

Safety shoe Viper 1+

Safety shoe, upper split leather; composite toe cap; 3D-dry lining; two-layered PU/TPU outsole with shock-absorbing FlexStep® mid-layer, oil- and chemical-resistant, antistatic; EN ISO 20345:S1 SRC



dpvlink 18497

Article	Color	Size	Category
Safety shoe Viper 1+			
SI-52124	black / green	35-47	S1

Safety shoe Viper 2+ / Viper Roller+

Safety shoe, upper split leather; composite toe cap; puncture-resistant sole; 3D-dry lining; two-layered PU/TPU outsole with shock-absorbing FlexStep® mid-layer, oil- and chemical-resistant, antistatic; EN ISO 20345:S3 SRC



dpvlink 18499

Article	Color	Size	Category	Closure
Safety shoe Viper 2+ / Viper Roller+				
SI-52125	black / green	35-47	S3	Boa®
SI-52137	black / green	35-47	S3	lace fastening

Safety shoe Cobra 1 Roller+

Safety shoe; upper microfiber; plastic toe cap; steel penetration protection, 3D-dry lining; two-layer PU/RU outsole with FlexEnergy element of TPU Infinergy®, developed by BASF; oil- and chemical-resistant, antistatic. EN ISO 20345 S1P SRC



dpvlink 25968

Article	Color	Size	Category
Safety shoe Cobra 1 Roller+			
SI-52305	black / grey	35-48	S1P

Safety sandal Relax S1



Classic safety sandal with velcro fastener, closed heel cap; 3D-dry lining; shock-absorbing FlexStep® PU outsole, oil- and chemical-resistant, antistatic. EN ISO 20345: S1 SRC



dpvlink 14311

Article	Color	Size	Category	Standard width
Safety sandal Relax S1				
SI-52236	black	35-39	S1	10.5
SI-52236-XL	black	40-47	S1	12

Safety sandal Promo TR S1



Safety sandal; upper PU-coated leather; velcro fastener; aluminum heel cap; 3D-dry lining; shock-absorbing FlexStep® PU outsole, oil- and chemical-resistant, antistatic. EN ISO 20345 S1 SRC



dpvlink 13003

Article	Color	Size	Category
Safety sandal Promo TR S1			
SI-52162	black / orange	36-47	S1

Safety shoe Elixir XL / Elixir High XL+



Safety shoe; upper PU-coated leather/split leather; metal-free; closed heel; plastic toe cap; 3D-dry lining; PU outsole with shock-absorbing FlexStep® mid-layer, oil- and chemical-resistant, antistatic; EN ISO 20345:S3 SRC



dpvlink 20066

Article	Color	Size	Category	Form	Standard width
Safety shoe Elixir XL / Elixir High XL+					
SI-52772-XL	anthracite / turquoise	39-47	S3	low shoe	12
SI-52774-XL	anthracite / turquoise	39-47	S3	boot	12

Insoles

DryStep insole



suitable for Sievi sandals Ion Black 2, Art 2, Rom 2

- transfers moisture from the foot down to the lower layer of the insole and keeps your feet dry
- machine washable at 40°C

dpvlink 15569

Article	Type	Size
DryStep insole		
SI-99610	suitable for Sievi sandals Ion Black 2, Art 2, Rom 2	36-47

Dual Comfort insole



suitable for all Sievi shoes with exchangeable insole



- shock-absorbing PORON® cushioning in the heel
- soft upper material
- breathable and moisture-absorbing mid-layer
- light, shock-absorbing EVA bottom layer

dpvlink 15567

Article	Type	Size
Dual Comfort insole		
SI-99525	Dual Comfort standard	34-48
SI-99527-XL	Dual Comfort XL	39-50

Dual Comfort Plus insole



suitable for all Sievi shoes with exchangeable insole



- Sievi Balance arch support
- shock-absorbing PORON® cushioning in the heel
- soft upper material
- breathable and moisture-absorbing mid-layer
- light and shock-absorbing EVA bottom layer

dpvlink 15568

Article	Type	Size
Dual Comfort Plus insole		
SI-99530	Dual Comfort Plus +Neutral Arch+	35-48
SI-99532-XL	Dual Comfort Plus XL +Neutral Arch+	39-48
SI-99534	Dual Comfort Plus +High Arch+	35-48
SI-99536-XL	Dual Comfort Plus XL +High Arch+	39-48



LUPOS

The king is back

PRODUCTS FOR EVERY NEED

LUPOS® offers a collection of safety shoes classified by the requirements. The characteristics that come together in the shoes are the robustness and the technology of the materials.



The materials used, the profound adaptation studies, the cutting-edge technology have allowed to implement a series of products that are synonyms for guarantee, efficiency and durability, ensuring lasting well-being. Thanks to the lightness of the materials these shoes are ideal for every sector of work and for any activity for free time and cannot only be worn in different work environments, but also in the most extreme situations.

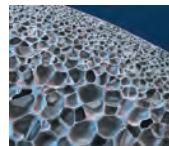













Lightness and flexibility in a single product.

Infenergy® by BASF was developed to store the energy caused as the foot hits the ground and to return it through the sole as the foot lifts up, pushing the foot forward. A large amount of the expended energy is returned to the wearer.

CAP LIGHT aluminium The CapLight technology is used with the production of all LUPOS® work shoes

The perforated safety cap 200J with breathable membrane that is half the weight of a traditional model. Athermic, antimagnetic and corrosion-resistant!

-  **ESD approved shoes**
in accordance with EN 61340
-  **Work shoes O2**
in accordance with EN ISO 20347
-  **Safety shoes S1P**
in accordance with EN ISO 20345
-  **Safety shoes S3**
in accordance with EN ISO 20345
-  **Aluminum toe cap**
-  **Slip resistance SRC**
in accordance with EN 13287
-  **Penetration protection metal-free**
-  **Vegan shoe**
-  **Exchangeable insole**
-  **DGUV standard 112-191**
Suitable for orthopedic insoles in accordance with DGUV standard 112-191
-  **Cushioning system Infenergy®**
by BASF. Excellent cushioning properties. Permanently gently on the joints
-  **Toe cap CAP LIGHT® aluminium**
Perforated 200J aluminum toe cap

Safety shoes

Safety shoe Cooper



Safety shoe; upper Putek® PLUS; with integrated band; very breathable, absorbent lining; Infenergy® midsole; toe cap; PU outsole with slight heel; oil-, acid and fuel-resistant; 100% vegan; slip-resistant. EN ISO 20345:2011 S3 CI SRC



dpvlink 27387

Article	Color	Size	Category	Protective toe cap
Safety shoe Cooper				
LU-20284	black / grey	38-47	S3	aluminum



Safety shoe Warner / Nichols / Quimby



Lightweight safety shoe; upper of breathable nylon and abrasion-resistant overcap protection; thin, perforated aluminum toe cap; metal-free penetration protection; Wingtex lining with ventilation channels; PU outsole; oil-, acid and fuel-resistant; slip-resistant; antistatic. EN ISO 20345:2011 S1P SRC



dpvlink 26497

Article	Color	Size	Category	Form
Safety shoe Warner / Nichols / Quimby				
LU-20026LV	black / grey	35-48	S3	low shoe
LU-20056LV	black / rose	35-42	S1P	low shoe
LU-20036LV	black / orange	35-48	S1P	low shoe



Safety sandal Jake



Safety sandal; upper soft pull-up leather or suede; with integrated band; thin, perforated aluminum toe cap; metal-free penetration protection; very breathable, absorbent lining; Infenergy® midsole; PU outsole with a slightly increased heel; oil-, acid and fuel-resistant; slip-resistant; antistatic. EN ISO 20345:2011 S1P SRC



dpvlink 23345

Article	Color	Size	Category	Upper
Safety sandal Jake				
LU-30076	black	38-48	S1P	leather



Shoe Entics / Entics Pro / Nach



Safety shoe; upper Putek® PLUS; with integrated band; very breathable, absorbent lining; Infinergy® midsole; PU outsole; oil-, acid and fuel-resistant; slip-resistant (SRC).

Variant safety shoe S3 additionally with aluminum toe cap and metal-free penetration protection



dpvlink 23489



Article	Color	Size	Category	Protective toe cap	Form
Shoe Entics / Entics Pro / Nach					
LU-20477	black	38-48	O2	none	low shoe
LU-20174	black	35-48	S3	aluminum	low shoe
LU-10174	black	35-48	S3	aluminum	boot

Shoe Dex / Ollie



Safety shoe; upper very breathable nylon with suede; with integrated band; very breathable, absorbent lining; Infinergy® midsole; PU outsole with a slightly increased heel; oil-, acid and fuel-resistant; slip-resistant (SRC).



dpvlink 23513



Article	Color	Size	Category	Form
Shoe Dex / Ollie				
LU-20366	black	38-47	S1P	low shoe
LU-20526	black / blue	35-48	S1P	low shoe

Safety shoe Emis / Lil



Safety shoe; upper microfiber; with integrated band; thin, perforated aluminum toe cap; metal-free penetration protection; very breathable, absorbent lining; Infinergy® midsole; PU outsole with a slightly increased heel; oil-, acid and fuel-resistant; slip-resistant; antistatic. 100% vegan

Emis LU-20166 EN ISO 20345:2011 S1P SRC
Lil LU-20374 EN ISO 20345:2011 S3 CI SRC



dpvlink 23516



Article	Color	Size	Category	Form
Safety shoe Emis / Lil				
LU-20166	white / grey	35-47	S1P	low shoe
LU-20374	white / blue	35-47	S3	low shoe

Shoe Sylvia



Safety shoe; upper Putek® PLUS; with integrated band; very breathable, absorbent lining; Infinergy® midsole; PU outsole with a slightly increased heel; oil-, acid and fuel-resistant; 100% vegan; slip-resistant (SRC).



dpvlink 23519



Article	Color	Size	Category	Protective toe cap
Shoe Sylvia				
LU-20384	black / rose	35-42	S3	aluminum







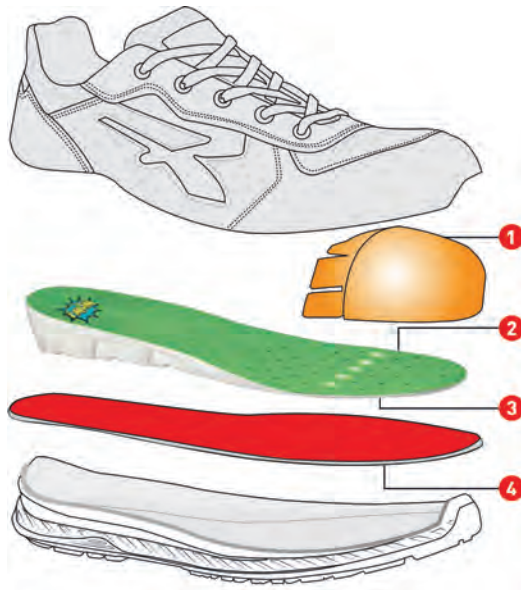











The continuous research and development of U-POWER surprises with an innovative insole. The best technologies are combined providing an experience of absolute comfort for each and every one!

This results in an immediate well-being when wearing the shoe for the very first time which reflects a reduced fatigue during every workday.



1. **AirToe**
protective toe cap 200J
2. **WOW & BASF**
Anatomic, soft insole for optimal support and perfect shock absorption combined with an anti-fatigue element and ventilation channels
3. **Seamless**
New seamless antistatic technology for an increased comfort. No pressure spots and no rubbing on the sole of the foot
4. **Save & FLEX plus**
"No metal" insole with penetration protection. 100% protection of the foot surface

- | | |
|--|---|
|  ESD approved shoes
in accordance with EN 61340 |  Penetration protection metal-free |
|  Work shoes 01
in accordance with EN ISO 20347 |  100% metal-free shoe |
|  Safety shoes S1P
in accordance with EN ISO 20345 |  Overcap
Toe wear protection |
|  Safety shoes S1PS according to EN ISO 20345:2022 |  Exchangeable insole |
|  Safety shoes S3
in accordance with EN ISO 20345 |  DGVU standard 112-191
Suitable for orthopedic insoles in accordance with DGVU standard 112-191 |
|  Aluminum toe cap |  Cushioning system Infinergy®
by BASF. Excellent cushioning properties. Permanently gently on the joints |
|  Metal-free toe cap |  Toe cap Airtoe Composite
200 Joule composite safety toe cap |
|  Slip resistance SR according to EN 13287 |  Puncture-resistant insole Save&Flex plus
Metal-free. 100% protection of foot surface |

 **Slip resistance SRC**
in accordance with EN 13287

 **Anatomic, soft insole**
for optimal grip and perfect shock absorption

Safety shoes

Professional shoe Connor RED PRO   



Occupational shoe; breathable nylon and soft suede upper; WingTex lining; footbed WOW Gel; PU midsole; PU/PU and Infinergy outsole; oil-resistant; slip-resistant; antistatic. EN ISO 20345:2011



dpvlink 28250

Article	Color	Size	Category	Form
Professional shoe Connor RED PRO				
UP-20067	white	35-48	01	low shoe unisex

Occupational shoe Caeli / Nate / Asher RED PRO   

Occupational shoe; upper of breathable nylon and soft suede; WingTex lining; WOW Gel insole; PU midsole; PU/PU und Infinergy® outsole; oil-resistant; slip-resistant; antistatic. EN ISO 20345:2011 01 FO SRC



dpvlink 26469

Article	Color	Size	Category	Form
Occupational shoe Caeli / Nate / Asher RED PRO				
UP-20059	black / pink	35-42	01	low shoe women
UP-20019	black / green	35-48	01	low shoe unisex
UP-20029	black / yellow	35-48	01	low shoe unisex

Safety shoe Blink / Candy RED LION   

Safety shoe; perforated aluminum toe cap; metal-free penetration protection; breathable lining; footbed with sole core made of Infinergy® from BASF; PU/PU outsole; oil-resistant; slip-resistant; antistatic. EN ISO 20345:2011



dpvlink 28252

Article	Color	Size	Category	Form
Safety shoe Blink / Candy RED LION				
UP-20334RL	white	35-48	S3	low shoe
UP-20324RL	grey / pink	35-42	S3	low shoe

Safety shoes Mars / Prince / Taylor / Lamar / Jackson RED SMART 

Safety shoe; multiple upper options; composite toe cap; metal-free penetration protection; breathable lining; PU outsole; oil-resistant; slip-resistant; antistatic. EN ISO 20345:2011



dpvlink 28254 

Article	Color	Upper	Size	Category
UP-20046RK	grey	suede / mesh	35-48	S1PS
UP-30076RK	grey / black	suede / mesh	35-48	S1PS
UP-20016RK	black / green	suede / PU-coated	35-48	S1PS
UP-20056RK	grey	suede / mesh	35-48	S1PS
UP-20104RK	black / grey	Putek® PLUS	35-48	S3S

Safety shoes Moki / Irvin / Egon / Elvis / Icarus / Ivy RED PREMIUM 

Safety shoe; multiple upper options; aluminum toe cap; metal-free penetration protection; soft white calfskin lining; PU outsole; PU midsole; oil-resistant; slip-resistant; antistatic. EN ISO 20345:2011



dpvlink 28295 

Article	Color	Upper	Size	Category
UP-20056RN	grey / orange	microfiber	35-48	S1P
UP-20036RN	black / orange	nylon	35-48	S1P
UP-20016RN	grey / green	nylon / microfiber	35-48	S1P
UP-20026RN	black / yellow	nylon / microfiber	35-48	S1P
UP-20046RN	grey	nylon / microfiber	35-48	S1P
UP-20126RN	grey / pink	nylon / microfiber	35-42	S1P

Safety sandal Gary RED LEVE 

Safety sandal; microfiber upper with nubuck-effect; WingTex lining; PU midsole; PU outsole; aluminum toe cap; PU outsole; oil-resistant; slip-resistant; antistatic. EN ISO 20345:2011



dpvlink 28293 

Article	Color	Size	Category	Form
Safety sandal Gary RED LEVE				
UP-30336RL	black	35-48	S1P	sandal unisex

Safety shoe Scott / Adam / Mike / Bradley / Robin / Frank RED LEVE 

Ultralight safety shoes; upper of breathable nylon; abrasion-resistant overcap protection; WingTex® lining; perforated aluminum toe cap; outsole made of PU mix; oil-resistant; slip-resistant; antistatic. EN ISO 20345:2011 S1P SRC



dpvlink 26489 

Article	Color	Size	Category	Form
Safety shoe Scott / Adam / Mike / Bradley / Robin / Frank RED LEVE				
UP-20116RL	black	35-48	S1P	low shoe
UP-20076RL	black / grey	35-48	S1P	low shoe
UP-20066RL	black / green	35-48	S1P	low shoe
UP-20144RL	black / orange	35-48	S1P	low shoe
UP-20096RL	black / green	35-48	S1P	low shoe
UP-20036RL	black	35-48	S1P	low shoe

Safety shoes Michelle RED LEVE 

Light safety shoe; upper of breathable nylon and abrasion-resistant overcap protection; WingTex® lining; outsole made of PU and InEnergy®; oil-resistant; slip-resistant; antistatic. EN ISO 20345:2011 S1P SRC



dpvlink 26487 

Article	Color	Size	Category	Form
Safety shoes Michelle RED LEVE				
UP-20086RL	black / rose	35-42	S1P	low shoe women

Safety shoe Negan / Sniper / Ryder / Gang / Saber 360



Safety shoe; upper suede, breathable nylon elements; perforated aluminum toe cap; metal-free penetration protection; breathable lining; insole with Infinergy® sole core by BASF; PU/PU outsole; oil-resistant; slip-resistant; antistatic.
EN ISO 20345:2011 S1P SRC



dpwlink 25770

Article	Color	Size	Category	Form
Safety shoe Negan / Sniper / Ryder / Gang / Saber 360				
UP-20026	grey / green	35-48	S1P	low shoe
UP-20056	grey / yellow	35-48	S1P	low shoe
UP-20016	grey / orange	35-48	S1P	low shoe
UP-20076	blue / orange	35-48	S1P	low shoe
UP-20046	grey	35-48	S1P	low shoe

Safety shoes Blaster / Mason 360



Safety shoe; upper suede, perforated aluminum toe cap; metal-free penetration protection; breathable lining; insole with Infinergy® sole core by BASF; PU/PU outsole; oil-resistant; slip-resistant; antistatic. EN ISO 20345:2011 S1P SRC



dpwlink 25784

Article	Color	Size	Category	Form
Safety shoes Blaster / Mason 360				
UP-20106	blue / black	35-48	S1P	low shoe
UP-10106	blue / black	35-48	S1P	boot

Safety shoe Kate 360



Safety shoe; upper suede, breathable nylon elements; perforated aluminum toe cap; metal-free penetration protection; breathable lining; insole with Infinergy® sole core by BASF; PU/PU outsole; oil-resistant; slip-resistant; antistatic.
EN ISO 20345:2011 S1P SRC



dpwlink 25778

Article	Color	Size	Category	Form
Safety shoe Kate 360				
UP-20176	grey / rose	35-42	S1P	low shoe

Safety shoe Aron 360



Safety shoe; upper suede, ultra breathable nylon elements; perforated aluminum toe cap; metal-free penetration protection; breathable lining; insole with Infinergy® sole core by BASF; PU/PU outsole; oil-resistant; slip-resistant; antistatic.
EN ISO 20345:2011 S1P SRC



dpwlink 25782

Article	Color	Size	Category	Form
Safety shoe Aron 360				
UP-20096	grey	35-48	S1P	low shoe

Safety shoe Specter 360



Safety shoe; upper suede, ultra breathable nylon elements; perforated aluminum toe cap; metal-free penetration protection; breathable lining; insole with Infinergy® sole core by BASF; PU/PU outsole; oil-resistant; slip-resistant; antistatic.
EN ISO 20345:2011 S1P SRC



dpwlink 25780

Article	Color	Size	Category	Form
Safety shoe Specter 360				
UP-20036	grey / green	35-48	S1P	low shoe

Safety shoes Strong / Kindle / Raptor / Hard / Monster LION



Safety shoes; upper Putek®, perforated aluminum toe cap; metal-free penetration protection; breathable lining; insole with Infinergy® sole core by BASF; PU/PU outsole; oil-resistant; slip-resistant; antistatic. EN ISO 20345:2011 S3 CI SRC



dpvlink 25787

Article	Color	Size	Category	Closure	Form
Safety shoes Strong / Kindle / Raptor / Hard / Monster LION					
UP-20366	black / green	38-48	S3	Boa®	low shoe
UP-20404	black / orange	35-48	S3	lace fastening	low shoe
UP-20376	black / grey	35-48	S3	lace fastening	low shoe
UP-20356	black / green	38-48	S3	lace fastening	low shoe
UP-10356	black / green	38-48	S3	lace fastening	boot

Safety sandal Cody LION



Safety sandal; upper of soft, perforated suede; WingTex® lining; WOW insole; PU midsole; outsole made of PU und Infinergy®; oil-resistant; slip-resistant; antistatic. EN ISO 20345:2011 S1P SRC



dpvlink 26503

Article	Color	Size	Category	Form
Safety sandal Cody LION				
UP-30316	black / red	35-48	S1P	sandal unisex

Safety shoe Shanghai INDUSTRY



Safety shoe; upper abrasion-resistant microfiber, breathable nylon elements; perforated composite toe cap; metal-free penetration protection; breathable microfiber lining; insole with anti-fatigue insert; PU midsole; abrasion-resistant PU/PU outsole; oil-resistant; slip-resistant; antistatic. EN ISO 20345:2011 S1P SRC



dpvlink 24829

Article	Color	Size	Category	Form
Safety shoe Shanghai INDUSTRY				
UP-21226	black / grey	35-48	S1P	low shoe

Safety shoe Denver / Vortex / Tokyo INDUSTRY



Safety shoe; upper perforated suede, breathable mesh elements; perforated composite toe cap; metal-free penetration protection; breathable microfiber lining; insole with anti-fatigue insert; PU midsole; abrasion-resistant PU/PU outsole; oil-resistant; slip-resistant; antistatic. EN ISO 20345:2011 S1P SRC



dpvlink 24821

Article	Color	Size	Category	Form
Safety shoe Denver / Vortex / Tokyo INDUSTRY				
UP-21086	grey / green	35-48	S1P	low shoe unisex
UP-20666	black / yellow	35-47	S1P	low shoe unisex
UP-21076	grey / pink	35-42	S1P	low shoe women

Safety shoe Marsiglia / Nairobi / Demon INDUSTRY



Safety shoe; upper perforated suede, breathable nylon elements; perforated composite toe cap; metal-free penetration protection; breathable microfiber lining; insole with anti-fatigue insert; PU midsole; abrasion-resistant PU/PU outsole; oil-resistant; slip-resistant; antistatic. EN ISO 20345:2011 S1P SRC



dpvlink 24825

Article	Color	Size	Category	Form
Safety shoe Marsiglia / Nairobi / Demon INDUSTRY				
UP-21106	black / yellow	35-48	S1P	low shoe
UP-21096	black / orange	35-48	S1P	low shoe
UP-20066	grey / red	38-47	S1P	low shoe

Maximal protection and comfort combined with environmental awareness

All models of the series INDUSTRY Green are produced by using renewable raw materials and recycled materials.



Using materials with a low environmental impact and the balance of residual emissions, zero CO2 emissions are achieved.

SOLE and FOOTBED:

- PU by BASF 100% made of renewable resources

LEG AND PENETRATION PROTECTION:

- large proportion made of recycled material



Safety shoe Canyon INDUSTRY Green



Sustainable safety shoe from CO₂ emission-neutral production; upper soft microfiber, breathable elements; perforated aluminum toe cap; completely metal-free; breathable microfiber lining with high recycling proportion; insole and PU/PU outsole made of completely renewable raw materials; oil-resistant; slip-resistant; antistatic. EN ISO 20345:2011 S1P SRC



dpvlink 25790

Article	Color	Size	Category	Form
Safety shoe Canyon INDUSTRY Green				
UP-20346	black / green	35-48	S1P	low shoe



Safety shoe Island INDUSTRY Green



Sustainable safety shoe from CO₂ emission-neutral production; upper Putek®, light-weight composite toe cap; completely metal-free; breathable microfiber lining with high recycling proportion; insole and PU/PU outsole made of completely renewable raw materials; oil-resistant; slip-resistant; antistatic. EN ISO 20345:2011 S3 SRC



dpvlink 25792

Article	Color	Size	Category	Form
Safety shoe Island INDUSTRY Green				
UP-20334	black / green	35-48	S3	low shoe



Insoles

Insole WOW



suitable for all U-Power and Lupos shoes with exchangeable insole.



- breathable
- anatomic Elastopan structure by BASF distributes the body weight evenly

dpvlink 25832

Article	Type	Size
Insole WOW		
UP-00604	Insole WOW	35-48



Insole WOW2



suitable for INDUSTRY shoes and all Lupos shoes with exchangeable insole.



- breathable
- anatomic Elastopan structure by BASF distributes the body weight evenly
- anti-fatigue insert

dpvlink 25841

Article	Type	Size
Insole WOW2		
UP-00605	Insole WOW2	35-48



ELTEN

Take a walk on the safe side

Elten is nowadays one of the leading safety shoe manufacturers. For Elten the well-being and safety of the wearer is of top priority when producing its safety shoes. The shoes are characterized by a high quality and have a good fitting. To ensure also a high level of wearing comfort and safety, Elten uses innovative technologies with the manufacturing of its safety shoes.

In compliance with the ESD standard DIN EN 61340-5-1



Infinergy

- ESD approved shoes**
in accordance with EN 61340
- Work shoes OB**
in accordance with EN ISO 20347
- Work shoes O1**
in accordance with EN ISO 20347
- Work shoes O2**
in accordance with EN ISO 20347
- Safety shoes S1**
in accordance with EN ISO 20345
- Safety shoes S1P**
in accordance with EN ISO 20345
- Safety shoes S1PL according to EN ISO 20345:2022**
- Safety shoes S1PS according to EN ISO 20345:2022**
- Safety shoes S2**
in accordance with EN ISO 20345
- Safety shoes S3**
in accordance with EN ISO 20345
- Safety shoes S3S according to EN ISO 20345:2022**
- Steel toe cap**
- Aluminum toe cap**
- Metal-free toe cap**
- Slip resistance SR according to EN 13287**
- Slip resistance SRA**
in accordance with EN 13287
- Slip resistance SRB**
in accordance with EN 13287
- Slip resistance SRC**
in accordance with EN 13287
- Penetration protection metal-free**
- 100% metal-free shoe**
- Overcap**
Toe wear protection
- Vegan shoe**
- Exchangeable insole**
- DGVU standard 112-191**
Suitable for orthopedic insoles in accordance with DGVU standard 112-191
- Cushioning system Infinergy**
by BASF. Excellent cushioning properties. Permanently gently on the joints
- BOA® closure system**
for an easy fitting of the shoe
- GORE-TEX® Membrane**
Waterproof and breathable lining material
- Reflective materials**
increase safety in the twilight and the dark

Clogs

Occupational clog MICHEL / MIA



Clog; upper microfiber; heel strap for an individual adaption to the foot; instep area adjustable with velcro fastener; breathable textile lining; metal- and leather-free equipment; MONO-PU outsole C-FIT, oil- and chemical-resistant; slip-resistant. EN ISO 20347 O2 SRC



dpvlink 22543



Article	Color	Size	
Occupational clog MICHEL / MIA			
EL-972430	black	40-48	men
EL-972440	white	40-48	men
EL-974430	black	35-42	women
EL-974440	white	35-42	women

Professional and safety footwear

Sneaker MAROON



Sporty sneaker; upper cowhide; leather lining; padded flap; steel toe cap; TPU/PU outsole L10, oil- and chemical-resistant; slip-resistant SRC



dpvlink 22564



Article	Color	Size	Category	Protective toe cap
Sneaker MAROON				
EL-72110	brown	37-47	S2	steel

Safety sandal JORAN red Easy



Safety sandal; textile upper; plastic toe cap; overcap; breathable textile lining; TPU/EVA midsole; rubber outsole; metal-free penetration protection; outsole: oil and chemical resistant, antistatic; slip-resistant. EN ISO 20345 S1PL SR



dpvlink 27924



Article	Color	Size	Category
Safety sandal JORAN red Easy			
EL-710801	black / red	36-48	S1PS

Safety shoe JORAN Low

Safety shoe; textile upper; plastic toe cap; overcap; breathable textile lining; TPU/EVA midsole; rubber outsole; metal-free penetration protection; outsole: oil and chemical resistant, antistatic; slip-resistant. EN ISO 20345 S3S SR



dpvlink 27921

Article	Color	Size	Category
Safety shoe JORAN Low			
EL-720851	black / blue	36-48	S3S
EL-720861	black / yellow	36-48	S3S

Safety shoe BREEZER

Safety shoe; nubuck; neon-yellow reflective material, padded flap; steel toe cap; breathable textile lining; TPU/PU outsole; optimal cushioning; outsole: oil- and chemical-resistant, antistatic; slip-resistance, EN ISO 20345 S1P SRC



dpvlink 19066

Article	Color	Size	Category	Form
Safety shoe BREEZER				
EL-72109	grey / yellow	37-47	S1	sneaker

Safety shoe SENSATION

Safety shoe; hydrophobized textile in jeans optics and hydrophobized nubuck, padded flap; steel toe cap; textile lining Bioactive; TPU/PU outsole; optimal cushioning; outsole: oil- and chemical-resistant, antistatic; slip-resistance, EN ISO 20345 S2 SRC



dpvlink 19058

Article	Color	Size	Category	Form
Safety shoe SENSATION				
EL-72106	black	37-47	S2	sneaker
EL-74106	black	35-42	S2	sneaker women
EL-76106	black	37-47	S2	boot

Safety shoe VINTAGE

Safety shoe: cowhide waxy in vintage design, padded flap; steel toe cap; textile lining Bioactive; non-metallic penetration protection; TPU/PU outsole; optimal cushioning; outsole: oil- and chemical-resistant, antistatic; slip-resistance, EN ISO 20345 S3 SRC



dpvlink 19064

Article	Color	Size	Category	Form
Safety shoe VINTAGE				
EL-74101	grey	35-42	S3	sneaker
EL-721071	grey	37-48	S3	sneaker
EL-74201	grey	35-42	S3	boot

Safety shoe JOURNEY

Safety shoe, padded flap; steel toe cap; partially metal-free penetration protection; breathable textile lining; TPU/PU outsole; optimal cushioning; outsole: oil- and chemical-resistant, antistatic; slip-resistant. EN ISO 20345 SRC



dpvlink 21132

Article	Color	Size	Category
Safety shoe JOURNEY			
EL-729621	black / blue	40-48	S1P
EL-729630	grey	40-48	S1

Low shoe MARAIS

Sporty professional shoe; upper mesh; padded flap; breathable textile lining; full-length ESD insole; rubber/TPU/EVA outsole TRANSFOAMERS, oil- and chemical resistant, antistatic; slip-resistant.



dpvlink 25985

Article	Color	Size	Category	Upper
Low shoe MARAIS				
EL-972020	black / blue	36-48	O1	mesh
EL-972010	black / red	36-48	O1	mesh
EL-972070	blue	36-48	O1	mesh
EL-972060	red	36-48	O1	mesh

Safety shoe LIVAS



Sporty safety shoe; upper mesh; padded flap; plastic toe cap; breathable textile lining; full-length ESD insole; rubber/TPU/EVA outsole TRANSFOAMERS, oil- and chemical resistant, antistatic; slip-resistant.



dpvlink 25991



Article	Color	Size	Category	Protective toe cap
Safety shoe LIVAS				
EL-720831	black / red	36-48	S1P	plastic
EL-720821	black / blue	36-48	S1P	plastic

Safety shoe MAVERICK / LAKERS



Safety shoe; upper microfiber with mesh element; padded flap; leather-free equipment; plastic toe cap; metal-free penetration protection; breathable textile lining; PU/PU outsole FUN; outsole: oil- and chemical-resistant, antistatic; slip-resistant. EN ISO 20345 S1P SRC



dpvlink 21447



Article	Color	Size	Category	Protective toe cap
Safety shoe MAVERICK / LAKERS				
EL-723351	blue	38-48	S1P	steel
EL-724451	black	35-49	S1P	plastic

WELLMA ELTEN Wellmaxx - ergonomic outsole

The outsole of the Wellmaxx line is equipped with an Infinergy® sole core of BASF. The innovative material does not only cushion the impact of the foot during walking, but also bounces back. The feet will become less tired relieving also tendons and joints. It is suitable especially for areas with hard floors.

MAXIMAL EFFECTIVITY

With every step Infinergy® absorbs enormous amounts of energy and keeps your feet healthy.

MAXIMAL WELLNESS

Infinergy® cushions the impact during walking and bounces simultaneously back.

MAXIMAL BOUNCE

Infinergy® returns a lot more energy and drive to you than conventional materials.

MAXIMAL PROTECTION OF THE JOINTS

The outstanding cushioning characteristics of Infinergy® steadily prevent the joints from damage.

MAXIMAL TEMPERATURE RESISTANCE

Infinergy® keeps it full functionality in a wide range from -20 to +80 degrees Celsius.

Safety shoe BROKER XXB low



Safety shoe; padded flap; microfiber upper; steel toe cap; breathable textile lining; WELLMAXX with sole core made of Infinergy® from BASF for optimal cushioning; outsole: oil and chemical resistant, antistatic; slip-resistant, EN ISO 20345 SRC



dpvlink 27885



Article	Color	Size	Category
Safety shoe BROKER XXB low			
EL-729310	black	39-49	S1
EL-729596	blue	39-49	S1

Safety sandal IAN XXTP blue AIR



Safety sandal; textile upper; plastic toe cap; breathable textile lining; WELLMAXX with sole core made of Infinergy® from BASF for optimal cushioning; metal-free penetration protection; outsole: oil and chemical resistant, antistatic; slip-resistant, EN ISO 20345 S1PS SRC



dpvlink 27914



Article	Color	Size	Category
Safety sandal IAN XXTP blue AIR			
EL-721341	black / blue	35-49	S1PS

Safety sandal IAN XXTP Easy



Safety sandal; textile upper; plastic toe cap; WELLMAXX with sole core made of Infinergy® from BASF for optimal cushioning; outsole: oil and chemical resistant, anti-static; slip-resistant, EN ISO 20345 SR



WELLMAXX



dpvlink 27916

Article	Color	Size	Category
Safety sandal IAN XXTP Easy			
EL-711310	black / red	35-48	S1
EL-711321	grey / black	35-49	S1PS

Safety sandal ALAN XXTP black-red Easy



Safety sandal; textile upper; plastic toe cap; breathable textile lining; WELLMAXX with sole core made of Infinergy® from BASF for optimal cushioning; metal-free penetration protection; outsole: oil and chemical resistant, antistatic; slip-resistant, EN ISO 20345 S1PS SRC



WELLMAXX



dpvlink 27919

Article	Color	Size	Category
Safety sandal ALAN XXTP black-red Easy			
EL-711351	black / red	35-49	S1PS

Safety shoe York XXE blue/black low



Safety shoe; microfiber/mesh; closed, padded flap and leg end; steel toe cap; breathable textile lining; rubber outsole WELLMAXX with sole core of Infinergy® by BASF for optimal cushioning; oil- and chemical-resistant, antistatic; slip-resistant. EN ISO 20345 SRC



WELLMAXX



dpvlink 27117

Article	Color	Size	Category
Safety shoe York XXE blue/black low			
EL-720705	blue / green	40-48	S1
EL-720701	black / white	40-48	S1P

Safety shoe Corby XXE black/blue low



Safety shoe; microfiber/mesh; closed, padded flap and leg end; steel toe cap; breathable textile lining; rubber outsole WELLMAXX with sole core of Infinergy® by BASF for optimal cushioning; oil- and chemical-resistant, antistatic; slip-resistant. EN ISO 20345 S1 SRC



WELLMAXX



dpvlink 27124

Article	Color	Size	Category
Safety shoe Corby XXE black/blue low			
EL-720715	blue / yellow	40-48	S1
EL-720710	black / grey	40-48	S1

Safety shoe Malcom grey low



Safety shoe; microfiber/mesh; closed, padded flap and leg end; steel toe cap; breathable textile lining; TPU outsole; PU midsole with sole core of Infinergy® by BASF for optimal cushioning; outsole: oil- and chemical-resistant, antistatic; slip-resistant. EN ISO 20345 S1 SRC



WELLMAXX



dpvlink 27127

Article	Color	Size	Category
Safety shoe Malcom grey low			
EL-729501	grey / black	40-48	S1P

Safety shoe LAKERS XXT



Sporty and lightweight safety shoe; upper mesh/microfiber; metal- and leather-free; padded flap; breathable textile lining; plastic toe cap; metal-free penetration protection; PU/PU outsole WELLMAXX TRAINERS with sole core of Infinergy® by BASF for optimal cushioning; oil- and chemical-resistant, antistatic; slip-resistant. EN ISO 20345 S1P SRC



WELLMAXX



dpvlink 22497

Article	Color	Size	Category	Form
Safety shoe LAKERS XXT				
EL-729711	black / red	36-48	S1P	low shoe
EL-769711	black / red	36-48	S1P	boot

Safety shoe MARTEN / MARTY



Safety shoe; upper seamless mesh; padded flap; steel toe cap; breathable textile lining; leather-free; TPU/PU outsole WELLMAXX SPORTS with sole core of Infinergy® by BASF for optimal cushioning; slip-resistant, EN ISO 20345 S1P/S3



dpvlink 24975

Article	Color	Size	Category	Form	Upper
---------	-------	------	----------	------	-------

Safety shoe MARTEN / MARTY

EL-728121	blue	35-48	S1P	low shoe	microfiber / mesh unisex
EL-728181	black / blue	40-48	S3	low shoe	textile / Cordura® men
EL-768121	blue	35-48	S1P	boot	microfiber / textile unisex

Safety shoe LARKIN



Sporty safety shoe; upper seamless mesh; padded flap; steel toe cap; breathable textile lining; leather-free; TPU/PU outsole WELLMAXX SPORTS with sole core of Infinergy® by BASF for optimal cushioning; slip-resistant, EN ISO 20345 S1 / S1P



dpvlink 24971

Article	Color	Size	Category
---------	-------	------	----------

Safety shoe LARKIN

EL-728111	black / grey	35-48	S1P
EL-728101	blue	35-48	S1P
EL-728110	black / blue	35-48	S1

Safety shoe IMPULSE XXT



Safety shoe; upper microfiber; breathable textile lining; plastic toe cap; PU/PU outsole WELLMAXX TRAINERS with sole core of Infinergy® by BASF for optimal cushioning; oil- and chemical-resistant, antistatic; slip-resistant. EN ISO 20345 S1 SRC



dpvlink 23181

Article	Color	Size	Category	Form
---------	-------	------	----------	------

Safety shoe IMPULSE XXT

EL-719755	black / blue	36-48	S1	sandal
EL-729755	black / blue	36-48	S1	low shoe

Safety shoe IMPULSE Lady XXTL



Safety shoe; upper microfiber; breathable textile lining; steel toe cap; metal-free penetration protection; PU/PU outsole WELLMAXX TRAINERS LADY with sole core of Infinergy® by BASF for optimal cushioning; oil- and chemical-resistant, antistatic; slip-resistant. EN ISO 20345 S1P SRC



dpvlink 25224

Article	Color	Size	Category	Form
---------	-------	------	----------	------

Safety shoe IMPULSE Lady XXTL

EL-742301	black / blue	35-42	S1P	low shoe
EL-741301	black / blue	35-42	S1P	sandal

Safety shoe SENSATION XXT



Modern safety shoe; upper hydrophobized textile with jeans look/hydrophobized nubuck; padded flap; breathable textile lining Bioactive; plastic toe cap; PU/PU outsole WELLMAXX TRAINERS with sole core of Infinergy® by BASF for optimal cushioning; oil- and chemical-resistant, antistatic; slip-resistant. EN ISO 20345 S2 SRC



dpvlink 22500

Article	Color	Size	Category	Form
Safety shoe SENSATION XXT				
EL-729720	jeans	36-48	S2	low shoe
EL-769720	jeans	36-48	S2	boot



Safety sandal SCOTT XXT



Comfortable safety sandal; upper mesh/microfiber; padded flap; breathable textile lining; plastic toe cap; metal-free penetration protection; PU/PU outsole WELLMAXX TRAINERS with sole core of Infinergy® by BASF for optimal cushioning; oil- and chemical-resistant, antistatic; slip-resistant. EN ISO 20345 S1P SRC



dpvlink 22503

Article	Color	Size	Category
Safety sandal SCOTT XXT			
EL-719731	black	36-48	S1P



Safety shoe SENEX XXT



Comfortable safety shoe; upper: water-repellent microfiber/water-repellent textile CORDURA®; closed and padded flap; breathable textile lining; plastic toe cap; metal-free penetration protection; PU/PU outsole WELLMAXX TRAINERS with sole core of Infinergy® by BASF for optimal cushioning; oil- and chemical-resistant, antistatic; slip-resistant. EN ISO 20345 S3 SRC



dpvlink 23151

Article	Color	Size	Category	Closure
EL-729731	black / red	36-48	S3	lace fastening
EL-729831	black / red	36-48	S3	Boa®



Safety shoe BREEZER XX10



Sporty safety shoe; upper nubuck; padded flap; breathable textile lining; steel toe cap; PU/PU outsole WELLMAXX L10 with sole core of Infinergy® by BASF; oil- and chemical-resistant, antistatic; slip-resistant. EN ISO 20345 S1 SRC



dpvlink 23173

Article	Color	Size	Category
Safety shoe BREEZER XX10			
EL-729925	black / red	36-48	S1



Safety shoe NEWTON black



Modern safety shoe; upper water-repellent textile/water-repellent nubuck; breathable textile lining; steel toe cap; PU/PU outsole WELLMAXX L10 with sole core of Infinergy® by BASF for optimal cushioning; oil- and chemical-resistant, antistatic; slip-resistant. EN ISO 20345 S2 SRC



dpvlink 23178

Article	Color	Size	Category	Form
Safety shoe NEWTON black				
EL-729910	black / grey	36-48	S2	low shoe



Safety shoe NEWTON



Modern safety shoe; upper water-repellent textile/water-repellent nubuck; breathable textile lining; steel toe cap; PU/PU outsole WELLMAXX L10 with sole core of Infinergy® by BASF for optimal cushioning; oil- and chemical-resistant, antistatic; slip-resistant. EN ISO 20345 S2 SRC



dpvlink 23175

Article	Color	Size	Category
Safety shoe NEWTON			
EL-729905	blue	36-48	S2



Safety shoe NED / NOEL



Sporty safety shoe; padded flap; breathable textile lining; steel toe cap; PU/PU outsole WELLMAXX L10 with sole core of Infinergy® by BASF for optimal cushioning; oil- and chemical-resistant, antistatic; slip-resistant. EN ISO 20345 S2 SRC



dpvlink 23189



Article	Color	Size	Category	Upper
Safety shoe NED / NOEL				
EL-729915	black	36-48	S2	leather
EL-729920	black / white	36-48	S2	microfiber

Safety shoe LONNY



Sporty safety shoe; upper mesh/microfiber; leather-free equipment; padded flap; breathable textile lining; steel toe cap; metal-free penetration protection; TPU/PU outsole MAXXIMO with sole core of Infinergy® by BASF for optimal cushioning; oil- and chemical-resistant, antistatic; slip-resistant. EN ISO 20345 SRC



dpvlink 22509



Article	Color	Size	Category	Form
Safety shoe LONNY				
EL-719521	black / red	35-48	S1P	sandal
EL-729521	black / red	35-48	S1P	low shoe
EL-729525	black / blue	35-48	S1	low shoe

Safety shoe LELAND GTX



Modern safety shoe; upper water-repellent textile/water-repellent microfiber; padded flap; GORE-TEX® Special Comfort Footwear lining; steel toe cap; metal-free penetration protection; TPU/PU outsole MAXXIMO with sole core of Infinergy® by BASF for optimal cushioning; oil- and chemical-resistant, antistatic; slip-resistant. EN ISO 20345 S3 SRC



dpvlink 23196



Article	Color	Size	Category	Form
Safety shoe LELAND GTX				
EL-729581	black / grey	40-48	S3	low shoe

Safety shoe LANCE



Modern safety shoe; upper textile/microfiber; padded flap; breathable textile lining; steel toe cap; metal-free penetration protection; TPU/PU outsole MAXXIMO with sole core of Infinergy® by BASF for optimal cushioning; oil- and chemical-resistant, antistatic; slip-resistant. EN ISO 20345 S1P SRC



dpvlink 24271



Article	Color	Size	Category	Form
Safety shoe LANCE				
EL-729695	grey	40-48	S1	low shoe
EL-729691	black	40-48	S1P	low shoe

Low shoe MADDOX



Sporty safety shoe; upper water-repellent textile/water-repellent microfiber/water-repellent nubuck; padded flap; breathable lining; leather-free; TPU/PU outsole MAXXIMO with sole core of Infinergy® by BASF for optimal cushioning; oil- and chemical-resistant, antistatic; slip-resistant.

Model MADDOX Black Leather (EL-929563) with upper water-repellent nubuck

Variant safety shoe S3 additionally with steel toe cap and metal-free penetration protection



dpvlink 23199



Article	Color	Size	Category	Protective toe cap
Low shoe MADDOX				
EL-929652	black / red	36-49	O2	none
EL-929563	black	36-49	O2	none
EL-729561	black / red	35-48	S3	steel
EL-729461	black / light grey	35-48	S3	steel

Safety shoe LANDON



Stylish safety shoe; upper microfiber/textile; padded flap; breathable textile lining; steel toe cap; metal-free penetration protection; TPU/PU outsole MAXXIMO with sole core of Infinergy® by BASF for optimal cushioning; oil- and chemical-resistant, antistatic; slip-resistant. EN ISO 20345 S1 SRC



dpvlink 23192

Article	Color	Size	Category
Safety shoe LANDON			
EL-729505	grey	40-48	S1



Low shoe MADDOX / MADDIE



Sporty professional shoe; padded flap; breathable textile lining; TPU/PU outsole with sole core of Infinergy® by BASF for optimal cushioning; optimal cushioning; outsole: oil- and chemical-resistant, antistatic; slip-resistant.

Variant safety shoe S1P additionally with steel toe cap and metal-free penetration protection



dpvlink 21128

Article	Color	Size	Category	Protective toe cap	Form
Low shoe MADDOX / MADDIE					
EL-949502	grey / blue	36-42	01	none	low shoe
EL-749501	grey / blue	35-42	S1P	steel	low shoe
EL-729551	grey / blue	40-48	S1P	steel	low shoe
EL-729571	blue	35-48	S1P	steel	low shoe
EL-749531	grey / blue	35-42	S1P	steel	sandal



Low shoe LANA



Modern occupational shoe; upper textile/microfiber; padded flap; breathable lining; TPU/PU outsole MAXXIMO with sole core of Infinergy® by BASF for optimal cushioning; oil- and chemical-resistant, antistatic; slip-resistant. EN ISO 20345 01 SRC



dpvlink 25227

Article	Color	Size	Category	Form
Low shoe LANA				
EL-974610	black / red	36-42	01	low shoe



Safety sandal ETHAN Easy



Safety sandal; microfiber, padded flap; plastic toe cap; non-metallic penetration protection; breathable textile lining; TPU/PU outsole; optimal cushioning; outsole: oil- and chemical-resistant, antistatic; slip-resistant, EN ISO 20345 S1 SRC



dpvlink 21126

Article	Color	Size	Category	Form
Safety sandal ETHAN Easy				
EL-719460	black	40-48	S1	sandal



Safety low shoe LUAN GREY-RED LOW ESD



Safety low shoe; mesh with recycled material/microfiber; padded tongue; steel toe cap; breathable textile lining; leather-free; metal-free penetration protection with recycled material; TPU/PU sole; optimal damping behavior; outsole: oil and chemical resistant, antistatic; slip-resistant, EN ISO 20345 S1PS SR



dpvlink 28177

Article	Color	Size	Category	Form
Safety low shoe LUAN GREY-RED LOW ESD				
EL-729121	grey / red	35-48	S1PS	low shoe



Safety low shoe LUANA GREY-TURQUOISE LOW ESD **NEU ELTEN** 

Safety low shoe; mesh with recycled material/microfiber; padded tongue; steel toe cap; breathable textile lining; leather-free; metal-free penetration protection with recycled material; TPU/PU sole; optimal damping behavior; outsole: oil and chemical resistant, antistatic; slip-resistant, EN ISO 20345 S1 SR



dpvlink 28179 

Article	Color	Size	Category	Form
Safety low shoe LUANA GREY-TURQUOISE LOW ESD				
EL-749125	grey / turquoise	35-42	S1	low shoe

Safety low shoe LUAN BLACK LOW ESD **NEU ELTEN** 

Safety low shoe; hydrophobic microfiber with recycled material; padded tongue; steel toe cap; breathable textile lining; leather-free; metal-free penetration protection with recycled material; TPU/PU sole; optimal damping behavior; outsole: oil and chemical resistant, antistatic; slip-resistant, EN ISO 20345 S3S SR



dpvlink 28181 

Article	Color	Size	Category	Form
Safety low shoe LUAN BLACK LOW ESD				
EL-720911	black	35-48	S3S	low shoe

Safety shoe IMPULSE Aqua **ELTEN** 

Safety shoe: microfiber; padded flap; steel toe cap; breathable textile lining; leather-free equipment; PU/PU outsole NOVA; optimal cushioning; outsole: oil- and chemical-resistant, antistatic; slip-resistance, EN ISO 20345 S1P SRC



dpvlink 20188 

Article	Color	Size	Category	Form	Closure
Safety shoe IMPULSE Aqua					
EL-74801	black / turquoise	35-42	S1P	sandal	velcro fastener
EL-74811	black / turquoise	35-42	S1P	low shoe	quick-release fastener
EL-74831	black / turquoise	35-42	S1P	low shoe	Boa®

Safety shoe IMPULSE Green **ELTEN** 

Lightweight safety shoe; upper microfiber; padded flap; plastic toe cap; breathable textile lining; TPU/PU outsole BIOMEX DYNAMICS; oil- and chemical-resistant, anti-static; slip-resistant. EN ISO 20345 S1P SRC



dpvlink 22519 

Article	Color	Size	Category	Form
Safety shoe IMPULSE Green				
EL-712551	black / green	36-47	S1P	sandal
EL-722551	black / green	36-47	S1P	low shoe
EL-762551	black / green	36-47	S1P	boot

Safety shoe MOTION AIR **ELTEN** 

Safety shoe: mesh material/microfiber, padded flap; plastic toe cap; textile lining Bioactive; TPU/PU outsole; optimal cushioning; outsole: oil- and chemical-resistant, antistatic; slip-resistance, EN ISO 20345 S1 SRC



dpvlink 19076 

Article	Color	Size	Category
Safety shoe MOTION AIR			
EL-72170	black / red	38-47	S1

Safety shoe MOTION **ELTEN** 

Safety shoe: hydrophobized microfiber/CORDURA®; metal-free; closed padded flap; plastic toe cap; breathable textile lining; TPU/PU outsole; optimal cushioning; outsole: oil- and chemical-resistant, antistatic; slip-resistance, EN ISO 20345 S2 SRC



dpvlink 19078 

Article	Color	Size	Category
Safety shoe MOTION			
EL-72182	black / grey	38-47	S2

Safety shoe SENEX / SCOTT



Safety shoe: microfiber/textile; metal-free; padded flap; plastic toe cap; breathable textile lining; TPU/PU outsole; outsole: oil- and chemical-resistant, antistatic; slip-resistance, EN ISO 20345 S1 SRC



dpvlink 20179

Article	Color	Size	Category	Closure
Safety shoe SENEX / SCOTT				
EL-72872	black / red	35-48	S2	lace fastening
EL-71872	black / red	35-48	S1	velcro fastener



Safety shoe AMBITION BOA



Safety shoe with BOA® closure system: hydrophobized nubuck/textile; closed, padded flap; steel toe cap; breathable textile lining; metal-free penetration protection; TPU/PU outsole DIMENSION PRO; optimal cushioning; outsole: oil- and chemical-resistant, antistatic; slip-resistance, EN ISO 20345 S2 SRC



dpvlink 19068

Article	Color	Size	Category
Safety shoe AMBITION BOA			
EL-72752	black / yellow	36-48	S2



Safety shoe MILA



Sporty safety shoe: padded flap; steel toe cap; partially metal-free penetration protection; breathable textile lining; PU/PU outsole NOVA; optimal cushioning; outsole: oil- and chemical-resistant, antistatic; slip-resistant, EN ISO 20345 SRC



dpvlink 22535

Article	Color	Size	Category	Form
Safety shoe MILA				
EL-74710	grey / turquoise	35-42	S1	sandal
EL-74720	grey / turquoise	35-42	S1	low shoe



Safety shoe OFFICER / OFFICER LADY



Elegant safety shoe; cowhide; padded flap; steel toe cap; leather lining; PU outsole; optimal cushioning; outsole: oil- and chemical-resistant, antistatic; slip-resistance, EN ISO 20345 S2 SRC



dpvlink 19088

Article	Color	Size	Category	Upper
Safety shoe OFFICER / OFFICER LADY				
EL-71307	black	40-48	S2	leather / perforated men
EL-74304	black	36-42	S2	leather / perforated women



Insoles

ESD insole



- ESD compliant
- anatomically shaped footbed
- dimensionally stable and permanently flexible
- odor-absorbing due to active carbon absorber
- high moisture absorption and release
- unisex and women's model



dpvlink 19195

Article	Type	Size	
ESD insole			
EL-204054	ESD PRO	35-52	unisex
EL-204056	ESD PRO LADY insole	35-42	women
EL-204094	ESD Insole Sportive	35-49	unisex













atlas® SAFETY SHOES

As one of the leading manufacturers of safety shoes in Europe Atlas sets a high value on high quality and innovative technologies. Its safety shoes are characterized by high-quality materials such as leather, Sportline textile or mesh as well as a breathable functional lining. Further features are the alu-tec® aluminum toe cap and the innovative Innoflex® sole concept. The safety shoes are also suitable for orthopedic insoles and offer an excellent ESD protection.

In compliance with the ESD standard DIN EN 61340-5-1 ⚠️



-  **ESD approved shoes**
in accordance with EN 61340
-  **Safety shoes SB**
in accordance with EN ISO 20345
-  **Safety shoes S1**
in accordance with EN ISO 20345
-  **Safety shoes S1P**
in accordance with EN ISO 20345
-  **Safety shoes S2**
in accordance with EN ISO 20345
-  **Safety shoes S3**
in accordance with EN ISO 20345
-  **Steel toe cap**
-  **Aluminum toe cap**
-  **Slip resistance SRC**
in accordance with EN 13287

-  **Penetration protection steel**
-  **Penetration protection metal-free**
-  **Exchangeable insole**
-  **DGVU standard 112-191**
Suitable for orthopedic insoles in accordance with DGVU standard 112-191
-  **BOA® closure system**
for an easy fitting of the shoe
-  **Cushioning MPU® comfort midsole**
for economical and fatigue-free walking
-  **Humidity regulation**
for a dry foot
-  **clima-stream®:**
Breathable shoe, acclimatizes to the ambient temperature

Safety shoes

Safety shoes Runner



Safety shoe; upper 100% woven and seamless textile, very comfortable and elastic Light Knit; steel toe cap; steel penetration protection; aktiv-X functional lining; 3D shock-absorption system; suitable for orthopedic insoles; ESD equipment, outsole oil-, acid- and benzene-resistant, antistatic; EN ISO 20345 S1P SRC



dpvlink 25874

Article	Color	Size	Category
Safety shoes Runner			
AT-83700ESD	black / white	36-48	S1P
AT-85000ESD	blue / rose	36-48	S1P
AT-49700ESD	grey / black	36-48	S1P



Safety shoe Runner 95 / 105



Safety shoe; microfiber upper, steel toe cap; metal-free penetration protection; aktiv-X functional lining; 3D shock-absorption system; suitable for orthopedic insoles; ESD equipment, outsole oil-, acid- and benzene-resistant, antistatic; EN ISO 20345 S3 SRC



dpvlink 27324

Article	Color	Size	Category	Form
Safety shoe Runner 95 / 105				
AT-89700	black / grey	36-48	S3	low shoe
AT-89900	black / grey	36-48	S3	boot



Safety shoe Runner Recycling



Safety shoe; PET upper made of REPVEVE® fibers; steel toe cap; steel penetration protection; aktiv-X functional lining; 3D shock-absorption system; suitable for orthopedic insoles; ESD equipment, outsole oil-, acid- and benzine-resistant, antistatic; EN ISO 20345 S1P SRC



„One green step further“

The result? A triple green safety shoe. **Upper, midsole and insole** are made of highly innovative materials and use intelligent processes in production for more efficient material recycling.

Upper

MESH upper becomes PET upper! The shaft of our recycling shoe consists of 92% recycled PET bottles. The material is called REPVEVE® polyester. To produce REPVEVE® polyester, plastic bottles and post-industrial waste collected worldwide are chopped, ground, washed and processed into high-quality flakes.

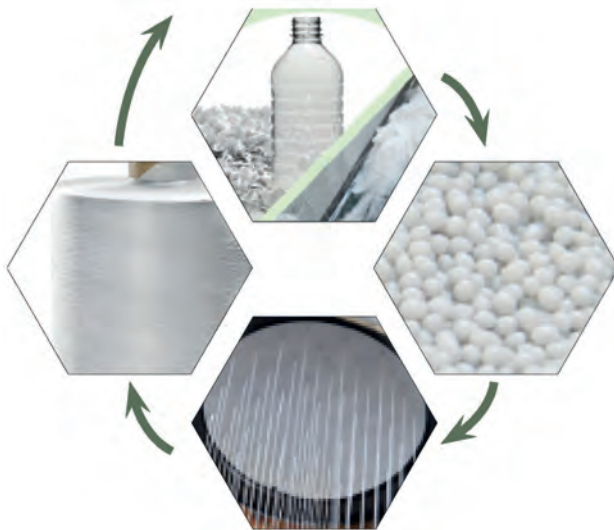

Midsole

Production waste naturally occurs during the manufacture of the midsole in the direct soling system. We now collect these PU residues, granulate them and return them to the production cycle. 20% of the midsole of the Recycling Safety Shoe consists of added solids due to this process. In the midsole production of a single shoe, we can therefore save one fifth of primary materials and thus reduce the use of raw materials (polyol and isocyanate).

Insole

The recycling insole Clima Comfort consists of 86% recycled ecofoam. The result is top-level comfort for your feet and sustainability for our planet. The composition of ecofoam is based on the complete reuse of all waste products, including those generated in the production of our foamed materials and insoles.



dpvlink 27329

Article	Color	Size	Category	Form
Safety shoe Runner Recycling				
AT-69400	green / white	36-48	S1P	low shoe



Safety shoe Flash 1000 / 1005 / 1300 / 1305 / 1600 / 1605



Safety shoe; upper mesh material, tip protection; alu-tec® aluminium toe cap; integrated climate zone; aktiv-X functional lining; MPU® INNOFLEX SYSTEM® sole; 3D shock-absorption for insoles, ESD equipment; outsole: oil-, acid- and fuel-resistant, antistatic; slip-resistant.



dpvlink 21071



Article	Color	Size	Category	Form	Closure
Safety shoe Flash 1000 / 1005 / 1300 / 1305 / 1600 / 1605					
AT-1000ESD	blue	36-48	S1	low shoe	lace fastening
AT-1000-1ESD	blue	49	S1	low shoe	lace fastening
AT-1005ESD	blue	36-48	S1P	low shoe	lace fastening
AT-1005-1ESD	blue	49	S1P	low shoe	lace fastening
AT-1300ESD	black	36-48	S1	low shoe	lace fastening
AT-1300-1ESD	black	49	S1	low shoe	lace fastening
AT-1305ESD	black	36-48	S1P	low shoe	lace fastening
AT-1305-1ESD	black	49	S1P	low shoe	lace fastening
AT-1600ESD	black	36-48	S1	sandal	velcro fastener
AT-1600-1ESD	black	49	S1	sandal	velcro fastener
AT-1605ESD	black	36-48	S1P	sandal	velcro fastener
AT-1605-1ESD	black	49	S1P	sandal	velcro fastener

Safety shoes Flash 2000 / 2005 / 3200 / 3205



Safety shoe; upper mesh material, neon reflective stripes, carbon-fiber reinforced tip protection; alu-tec® aluminium toe cap; integrated climate zone; aktiv-X functional lining; MPU® INNOFLEX SYSTEM® sole; 3D shock-absorption for insoles, ESD equipment; outsole: oil-, acid- and fuel-resistant, antistatic; slip-resistant.



dpvlink 21067



Article	Color	Size	Category	Closure
Safety shoes Flash 2000 / 2005 / 3200 / 3205				
AT-2000ESD	black	36-48	S1	lace fastening
AT-2000-1ESD	black	49	S1	lace fastening
AT-2005ESD	black	36-48	S1P	lace fastening
AT-2005-1ESD	black	49	S1P	lace fastening
AT-3200ESD	black	36-48	S1	Boa®
AT-3200-1ESD	black	49	S1	Boa®
AT-3205ESD	black	36-48	S1P	Boa®
AT-3205-1ESD	black	49	S1P	Boa®

Safety shoes Flash 2600 / 2605 XP®



Safety shoe; upper mesh material, neon reflective stripes, carbon-fiber reinforced tip protection; alu-tec® aluminium toe cap; integrated climate zone; aktiv-X functional lining; MPU® INNOFLEX SYSTEM® sole; 3D shock-absorption for insoles, ESD equipment; outsole: oil-, acid- and fuel-resistant, antistatic; slip-resistant.



dpvlink 21069

Article	Color	Size	Category
Safety shoes Flash 2600 / 2605 XP®			
AT-2600ESD	black / green	36-48	S1
AT-2600-1ESD.49	black / green	49	S1
AT-2605ESD	black / green	36-48	S1P
AT-2605-1ESD.49	black / green	49	S1P



Safety shoe Flash 3300 / 3305



Safety shoe; upper mesh material, tip protection; alu-tec® aluminium toe cap; integrated climate zone; aktiv-X functional lining; MPU® INNOFLEX SYSTEM® sole; 3D shock-absorption for insoles, ESD equipment; outsole: oil-, acid- and fuel-resistant, antistatic; slip-resistant.



dpvlink 27748

Article	Color	Size	Form	Closure
Safety shoe Flash 3300 / 3305				
AT-3300ESD	black / grey	36-48	low shoe	Boa®
AT-3305ESD	black / grey	36-49	low shoe	Boa®



Safety shoe Flash 4000 / 4005 / 4600 / 4605



Safety shoe; SPORTLINE upper material, carbon-fiber reinforced tip protection; alu-tec® aluminium toe cap; integrated climate zone; aktiv-X functional lining; MPU® INNOFLEX SYSTEM® sole; 3D cushioning system for insoles, ESD features; reflective neon stripes; outsole: oil- acid and benzene-resistant, antistatic; slip-resistant.



dpvlink 21018

Article	Color	Size	Category	Form	Closure
Safety shoe Flash 4000 / 4005 / 4600 / 4605					
AT-4000ESD	blue / green	36-48	S1	low shoe	lace fastening
AT-4000-1ESD	blue / green	49	S1	low shoe	lace fastening
AT-4005ESD	blue / green	36-48	S1P	low shoe	lace fastening
AT-4005-1ESD	blue / green	49	S1P	low shoe	lace fastening
AT-4600ESD	blue / green	36-48	S1	sandal	velcro fastener
AT-4600-1ESD	blue / green	49	S1	sandal	velcro fastener
AT-4605ESD	blue / green	36-48	S1P	sandal	velcro fastener
AT-4605-1ESD	blue / green	49	S1P	sandal	velcro fastener



Safety sandal SL26 2.0 / SL46 2.0



Safety sandal; carbon fiber reinforced tip protection; alu-tec® aluminum toe cap; clima-stream® functional lining; velcro fastener; MPU® INNOFLEX SYSTEM® sole; optimal damping behavior; suitable for orthopedic insoles; outsole: oil- and chemical-resistant, antistatic; slip-resistant. EN ISO 20345 S1 SRC



dpvlink 17905

Article	Color	Size	Category
Safety sandal SL26 2.0 / SL46 2.0			
AT-SL26ESD	black / green	36-48	S1
AT-SL26-1ESD	black / green	49	S1
AT-SL46ESD	black / blue	36-48	S1
AT-SL46-1ESD	black / blue	49	S1



Safety shoe SL20 / SL920 2.0 GREEN



Safety shoe; perforated SPORTLINE upper; carbon fiber reinforced tip protection; alu-tec® aluminum toe cap; clima-stream® functional lining; 3D cushioning system; suitable for orthopedic insoles; MPU® INNOFLEX SYSTEM® sole; outsole: oil- and chemical-resistant, antistatic; slip-resistant. EN ISO 20345 S1 SRC



dpvlink 17903

Article	Color	Size	Category	Closure
Safety shoe SL20 / SL920 2.0 GREEN				
AT-SL920ESD	black / green	36-48	S1	Boa®
AT-SL920-1ESD	black / green	49	S1	Boa®
AT-SL20ESD	black / green	36-48	S1	lace fastening
AT-SL20-1ESD	black / green	49	S1	lace fastening

Safety shoes SL40 / SL82 2.0 BLUE



Safety shoe; perforated SPORTLINE upper material; carbon fiber reinforced tip protection; alu-tec® aluminum toe cap; clima-stream® functional lining; MPU® INNOFLEX SYSTEM® sole; 3D cushioning system; suitable for orthopedic insoles, ESD equipment; outsole: oil- and chemical-resistant, antistatic; slip-resistant. EN ISO 20345 S1 SRC



dpvlink 17907

Article	Color	Size	Category	Form
Safety shoes SL40 / SL82 2.0 BLUE				
AT-SL40ESD	black / blue	36-48	S1	low shoe
AT-SL40-1ESD	black / blue	49	S1	low shoe
AT-SL82ESD	black / blue	36-48	S1	boot

Safety shoe SL60 / SL80 2.0 BLUE



Safety shoe; SOFT nubuck; carbon fiber reinforced MPU tip protection; alu-tec® aluminum toe cap; aktiv-X functional lining; MPU® INNOFLEX SYSTEM® sole; 3D cushioning system; suitable for orthopedic insoles, ESD equipment; outsole: oil- and chemical-resistant, antistatic; slip-resistant; EN ISO 20345 S2 SRC



dpvlink 19044

Article	Color	Size	Category	Form
Safety shoe SL60 / SL80 2.0 BLUE				
AT-SL60ESD	black / blue	36-48	S2	low shoe
AT-SL60-1ESD	black / blue	49	S2	low shoe
AT-SL80ESD	black / blue	36-48	S2	boot

Safety sandal SL36 2.0 RED



Safety sandal; SPORTLINE upper; carbon fiber reinforced tip protection; alu-tec® aluminum toe cap; clima-stream® functional lining; aktiv-X functional lining; velcro fastener; MPU® INNOFLEX SYSTEM® sole; 3D absorption system; suitable for orthopedic insoles; outsole: oil- and chemical-resistant, antistatic; slip-resistant. EN ISO 20345 S1 SRC



dpvlink 19199

Article	Color	Size	Category
Safety sandal SL36 2.0 RED			
AT-SL36ESD	black / red	36-48	S1
AT-SL36-1ESD	black / red	49	S1

Safety shoes SL30 / SL32 2.0 RED



Safety shoe; perforated SPORTLINE upper; carbon fiber reinforced tip protection; alu-tec® aluminum toe cap; clima-stream® functional lining; aktiv-X functional lining; MPU® INNOFLEX SYSTEM® sole; 3D absorption system; suitable for orthopedic insoles; outsole: oil- and chemical-resistant, antistatic; slip-resistant. EN ISO 20345 S1 SRC



dpvlink 19201

Article	Color	Size	Category	Form
Safety shoes SL30 / SL32 2.0 RED				
AT-SL30ESD	black / red	36-48	S1	low shoe
AT-SL30-1ESD	black / red	49	S1	low shoe
AT-SL32ESD	black / red	36-48	S1	boot

Safety shoe SL9405 2.0 XP® BOA®



Safety shoe; perforated SPORTLINE upper; aktiv-X functional lining; XP® metal-free penetration protection; carbon-fiber reinforced tip protection; alu-tec® aluminum toe cap; MPU®INNOFLEX SYSTEM® sole; 3D cushioning system; outsole: oil- and chemical-resistant, antistatic; slip-resistant. EN ISO 20345 S1P SRC



dpvlink 21609

Article	Color	Size	Category
Safety shoe SL9405 2.0 XP® BOA®			
AT-SL9405ESD	black / blue	36-48	S1P
AT-SL9405-1ESD.49	black / blue	49	S1P



Safety sneaker GX100/GX160/GX240/GX260



Safety shoe; upper mesh material with integrated climate zone; steel toe cap; aktiv-X functional lining; lacing; MPU® Light sole technology; 3D damping system for insoles; outsole: oil-, acid- and fuel-resistant, antistatic; slip-resistant; EN ISO 20345 S1 SRC



dpvlink 22605

Article	Color	Size	Category	Closure
Safety sneaker GX100/GX160/GX240/GX260				
AT-GX100ESD	blue / rose	35-43	S1	lace fastening
AT-GX160ESD	blue / rose	35-43	S1	velcro fastener
AT-GX240ESD	black / grey	35-43	S1	lace fastening
AT-GX260ESD	black / grey	35-43	S1	velcro fastener



Safety shoes GX130/GX133



Safety shoe; SPORTLINE upper material; steel toe cap, clima-stream® concept; aktiv-X functional lining; MPU® Light sole technology; 3D damping outsole: oil-, acid- and fuel-resistant, antistatic; slip-resistant according to EN ISO 20345 S1 SRC



dpvlink 20102

Article	Color	Size	Category
Safety shoes GX130/GX133			
AT-GX130ESD	black / blue	35-43	S1
AT-GX133ESD	black / red	35-43	S1



Safety sandal GX350 Black



Safety sandal; SPORTLINE upper material; clima-stream® concept; aktiv-X functional lining; Velcro fastener; MPU® Light sole technology; 3D damping system for insoles; outsole: oil-, acid- and fuel-resistant, antistatic; slip-resistant. EN ISO 20345 S1 SRC



dpvlink 20118

Article	Color	Size	Category
Safety sandal GX350 Black			
AT-GX350ESD	black / blue	35-43	S1



Safety clog GX 390 black



Safety clog; upper SPORTLINE; steel toe cap; clima-stream® functional lining; comfort insole; MPU® Light sole technology; antistatic; outsole: oil- and chemical-resistant, antistatic; slip-resistant. EN ISO 20345 SB SRC



dpvlink 19598

Article	Color	Size	Category
Safety clog GX 390 black			
AT-GX390ESD	black / blue	35-43	SB



Safety sandal TX360 S1 ESD



Safety sandal; SPORTLINE upper material; carbon-fiber reinforced MPU toe protection; clima-stream® concept; aktiv-X functional lining; Velcro fastener; MPU® Innoflex System sole technology; 3D damping system for insoles, ESD equipment; outsole: oil-, acid- and fuel-resistant, antistatic; slip-resistant according to EN ISO 20345 S1 SRC



dpvlink 20109

Article	Color	Size	Category
Safety sandal TX360 S1 ESD			
AT-TX360ESD	black / blue	36-48	S1
AT-TX360-1ESD	black / blue	49-50	S1



Safety shoe CF2



Safety shoe; upper microfiber; safety reflective stripes; carbon-fiber reinforced MPU toe protection; steel toe cap, clima-stream® concept; aktiv-X functional lining; 3D shock absorption; suitable for insoles, ESD equipment; MPU® Innoflex System sole technology; outsole: oil-, acid- and fuel-resistant, antistatic; EN ISO 20345 S1 SRC



dpvlink 21073

Article	Color	Size	Category
Safety shoe CF2			
AT-CF2ESD	black / blue	36-48	S1
AT-CF2-1ESD	black / blue	49	S1



Safety sneaker A420



Safety sneaker; upper material: SPROTLINE microfiber, partially perforated; steel toe cap; aktiv-X functional lining; 3D cushioning system, suitable for the insole equipment, ESD equipment, Sneaker sole technology; outsole oil- and chemical-resistant, antistatic; EN ISO 20345 S1



dpvlink 16922

Article	Color	Size	Category
Safety sneaker A420			
AT-A420ESD	black / blue	36-48	S1
AT-A420-1ESD	black / blue	49	S1



Safety sneaker A280/A585



Safety sneaker; upper material: soft full-grain leather; steel toe cap; metal-free penetration protection; aktiv-X functional lining; 3D cushioning system, suitable for orthopedic insoles, ESD equipment, Sneaker sole technology; outsole oil- and chemical-resistant, antistatic; AT-585ESD in addition with XP® metal-free penetration protection. EN ISO 20345 S2 / S3



dpvlink 20112

Article	Color	Size	Category	Form
Safety sneaker A280/A585				
AT-A280ESD	dark grey	36-48	S2	sneaker
AT-A280-1ESD	dark grey	49	S2	sneaker
AT-A585ESD	dark grey	36-48	S3	boot



Safety shoe CX 200 Office women



Women's safety shoe; upper leather, comfortable women's last, comfort heel: steel toe cap; aktiv-X functional lining; MPU® Office sole technology; 3D shock absorption for orthopedic insoles; oil- and chemical-resistant, antistatic; EN ISO 20345:S2



dpvlink 16921

Article	Color	Size	Category
Safety shoe CX 200 Office women			
AT-CX200ESD	black	35-43	S2



Safety shoe Office



Safety shoe; upper material: soft full-grain calf leather, steel toe cap, aktiv-X functional lining; lacing; MPU® Light sole technology; 3D damping system for insoles, ESD equipment; outsole: oil-, acid- and fuel-resistant, antistatic; slip-resistant according to EN ISO 20345 S2 SRC



dpvlink 20122

Article	Color	Size	Category	Form
Safety shoe Office				
AT-CX340ESD	black	39-48	S2	low shoe
AT-CX540ESD	black	39-47	S2	boot
AT-CX320ESD	black	39-47	S2	low shoe



Safety shoe CX



Safety shoe; upper breathable microfiber, steel toe cap, aktive-X functional lining, 3D shock absorption for orthopedic insoles, ESD equipment, MPU® sole technology; oil-, acid- and fuel-resistant, antistatic; EN ISO 20345 S1 SRC



dpvlink 21076

Article	Color	Size	Category
Safety shoe CX			
AT-CX50ESD	black	39-48	S1 men
AT-CX56ESD	grey	39-48	S1 men
AT-CX40ESD	black	35-43	S1 women
AT-CX46ESD	grey	35-43	S1 women



Insoles

ESD Clima Comfort insole



- suitable for all Atlas shoes
- ESD-compliant

dpvlink 21672

Article	Color	Size
ESD Clima Comfort insole		
AT-92000	green	36-48



uvex

Nothing is more important than the safety of people in their day-to-day work! This is why uvex is constantly developing their products based on pioneering technologies. The objective: combining protection, wearing comfort and relief in every product in the best possible way.



clima zone

uvex climazone is an innovative head-to-toe climate control system. uvex has combined its expertise in research and product development using intelligent materials and processing technologies to develop a unique range of climate-optimizing safety products, such as climate-optimizing safety footwear.

Hot or cold feet, discomfort caused by heavy perspiration - a perfect climate regulation is demanded especially in safety footwear:

- perceived comfort with uvex climazone
- regulation of the individual body climate
- working with a remaining well-being
- longer lasting performance
- optimal wearing comfort in every situation

The uvex comfortable climate insole provides all-over cushioning of the foot and ensures comfort in high-strain zones. It is breathable and is made of moisture-absorbing materials. The cushioning zones support the natural walking movement. The upper is skin-friendly and pleasant.



The uvex xenova® system is a performant, completely metal-free safety system to protect the foot inside a safety shoe. The uvex xenova® toe cap fits perfectly without any pressure points. The cap ensures increased wearer comfort when kneeling and during impacts.



ESD approved shoes
in accordance with EN 61340



Work shoes O1
in accordance with EN ISO 20347



Safety shoes S1
in accordance with EN ISO 20345



Safety shoes S1P
in accordance with EN ISO 20345



Safety shoes S1PL according to EN ISO 20345:2022



Safety shoes S2
in accordance with EN ISO 20345



Safety shoes S3
in accordance with EN ISO 20345



Steel toe cap



Metal-free toe cap



Slip resistance SR according to EN 13287



Slip resistance SRC
in accordance with EN 13287



Penetration protection steel



Penetration protection metal-free



Very lightweight shoe



Overcap
Toe wear protection



Exchangeable insole



DGUV standard 112-191
Suitable for orthopedic insoles in accordance with DGUV standard 112-191



BOA® closure system
for an easy fitting of the shoe



Completely metal-free toe cap xenova®

Occupational and safety footwear

Safety shoe uvex 1 x-craft **NEU uvex** 

Lightweight safety shoe; suitable for chrome allergy sufferers; x-dry knit upper; elastic laces; metal-free toe cap; overcap; TPU outsole; PU midsole; resistant to oil and petrol; slip-resistant. EN ISO 20345 S1PL SR F0



dpvlink 27978 

Article	Color	Size	Category	Upper
Safety shoe uvex 1 x-craft				
UX-68082	black / green	35-52	S1PL	x-dry knit

Safety shoe uvex 1 x-craft **NEU uvex** 

Lightweight safety shoe; suitable for chrome allergy sufferers; textile upper; elastic laces; metal-free toe cap; overcap; TPU outsole; PU midsole; resistant to oil and petrol; slip-resistant. EN ISO 20345 S1PL SR F0



dpvlink 27980 

Article	Color	Size	Category	Upper
Safety shoe uvex 1 x-craft				
UX-68002	black	35-52	S1PL	textile

Safety shoe uvex 1 x-craft **NEU uvex** 

Safety boot; suitable for chrome allergy sufferers; micro-suede upper; elastic laces; metal-free toe cap; overcap; TPU outsole; PU midsole; resistant to oil and petrol; slip-resistant. EN ISO 20345 S1PL SR F0



dpvlink 27982 

Article	Color	Size	Category	Upper
Safety shoe uvex 1 x-craft				
UX-68022	black / red	35-52	S1PL	micro suede
UX-68138	black / blue	35-52	S1	micro suede

Safety shoe ESD uvex 1 G2 Planet **uvex** 

Lightweight safety shoe made from 25% recycled material; suitable for persons suffering from chrome allergy; silicon-free sole material; elastic laces; metal-free penetration protection and toe cap; overcap; suitable for orthopedic insoles (DGUV), TPU outsole; oil- and benzine-resistant; very slip-resistant. EN ISO 20345:2011 S1P SRC



dpvlink 25845 

Article	Color	Size	Category	Upper
Safety shoe ESD uvex 1 G2 Planet				
UX-68232	white / green	35-52	S1P	textile
UX-68242	black / green	35-52	S1P	textile

Safety shoe ESD uvex 1 G2 **uvex** 

Lightweight safety shoe; suitable for persons suffering from chrome allergy; silicon-free sole material; elastic laces; metal-free toe cap; suitable for orthopedic insoles (DGUV), PU outsole; oil- and benzine-resistant; very slip-resistant. EN ISO 20345:2011 S1 SRC



dpvlink 25848 

Article	Color	Size	Category	Form
Safety shoe ESD uvex 1 G2				
UX-68298	black / blue	35-52	S1	low shoe
UX-68318	black / blue	35-52	S1	boot

Safety shoe uvex 1 G2



Lightweight safety shoe; suitable for persons suffering from chrome allergy; silicon-free sole material; elastic laces; metal-free penetration protection and toe cap; TPU overcap; women's last from sizes 35-40; oil- and benzene-resistant; slip-resistant. EN ISO 20345:2011 S1P SRC



dpvlink 26115

Article	Color	Size	Category	Upper
Safety shoe uvex 1 G2				
UX-68342	black / grey	35-52	S1P	textile
UX-68528	black / red	35-52	S1	x-dry knit



Safety sandal uvex 1 G2



Safety sandal; upper micro suede; perforated; with velcro fastener; large xenova® plastic toe cap; suitable for orthopedic insoles; very slip-resistant. UX-68428 and UX-68488: EN ISO 20345:2011 S1 SRC UX-68362: EN ISO 20345:2011 S1P SRC



dpvlink 24241

Article	Color	Size	Category	Form
Safety sandal uvex 1 G2				
UX-68428	black / yellow	35-52	S1	sandal
UX-68488	black / orange	35-52	S1	sandal
UX-68362	black / red	35-52	S1P	sandal
UX-68288	black / blue	35-52	S1	sandal



Safety shoe ESD uvex 1 G2



Safety shoe with quick-release fastener; upper micro suede (perforated); Distance mesh lining; large xenova® plastic toe cap; suitable for orthopedic insoles; TPU outsole; very slip-resistant. UX-68467 and UX-68438: EN ISO 20345:2011 S1 SRC UX-68372: EN ISO 20345:2011 S1P SRC



dpvlink 24866

Article	Color	Size	Category
Safety shoe ESD uvex 1 G2			
UX-68372	black / red	35-52	S1P
UX-68438	black / yellow	35-52	S1
UX-68468	black / orange	35-52	S1



Safety shoe ESD uvex 1



Safety shoe; upper micro suede; perforated; xenova® plastic toe cap; suitable for orthopedic insoles; PU/PU outsole; slip-resistant. EN ISO 20345:2011 S1 SRC



dpvlink 24233

Article	Color	Size	Category	Closure	Form
Safety shoe ESD uvex 1					
UX-85428	black / lime	35-52	S1	velcro fastener	sandal
UX-85438	black / lime	35-52	S1	quick-release fastener	low shoe
UX-65658	black / lime	35-52	S1	Boa®	low shoe



Safety shoe ESD uvex 1 ladies



Safety shoe; upper micro suede; perforated; large xenova® plastic toe cap; suitable for orthopedic insoles; PU/PU outsole; slip-resistant. EN ISO 20345:2011 S1 SRC



dpvlink 24290

Article	Color	Size	Category	Closure	Form
Safety shoe ESD uvex 1 ladies					
UX-85618	grey / pink	35-43	S1	quick-release fastener	low shoe
UX-85608	grey / pink	35-43	S1	velcro fastener	sandal



Professional shoe ESD uvex 1 Sport nc



Professional shoe; upper textile; suitable for orthopedic insoles; PU/PU outsole; slip-resistant. EN ISO 20347:2012 O1 SRC FO



dpvlink 24238

Article	Color	Size	Category	Upper	Form
Professional shoe ESD uvex 1 Sport nc					
UX-65938	black / grey	35-52	O1	textile	low shoe
UX-65958	black / white	35-52	O1	textile	low shoe
UX-65708	white	35-52	O1	textile	low shoe



Safety shoe ESD uvex 1 Sport



Safety shoe; upper textile; xenova® plastic toe cap; metal-free penetration protection; suitable for orthopedic insoles; PU/PU outsole; slip-resistant. EN ISO 20345:2011 S1P SRC



dpvlink 24227

Article	Color	Size	Category	Upper	Form
Safety shoe ESD uvex 1 Sport					
UX-65902	black	35-52	S1P	textile	low shoe



Safety shoe ESD uvex 1 Sport



Safety shoe; upper textile; xenova® plastic toe cap; suitable for orthopedic insoles; PU/PU outsole; slip-resistant. EN ISO 20345:2011 S1 SRC



dpvlink 24229

Article	Color	Size	Category	Upper	Form
Safety shoe ESD uvex 1 Sport					
UX-65992	blue	35-52	S1P	textile	low shoe
UX-65988	black	35-52	S1	textile	low shoe



Safety shoe uvex 2 xenova



Safety shoe; upper micro suede; perforated; reflective appliqué; xenova® plastic toe cap; suitable for orthopedic insoles; PU/PU outsole; slip-resistant. EN ISO 20345:2011 S1 SRC



dpvlink 24264

Article	Color	Size	Category	Closure	Form
Safety shoe uvex 2 xenova					
UX-95548	black / blue	38-52	S1	lace fastening	low shoe
UX-95538	black / blue	38-52	S1	velcro fastener	sandal



Safety shoe uvex 2 trend black/blue 

Safety shoe; upper micro suede; steel toe cap; suitable for orthopedic insoles; PU/PU outsole; very slip-resistant. EN ISO 20345:2011 S1/S1P SRC
 UX-69378: EN ISO 20345:2011 S1 SRC
 UX-69362: EN ISO 20345:2011 S1P SRC



dpvlink 24280

Article	Color	Size	Category	Closure	Form
---------	-------	------	----------	---------	------

Safety shoe uvex 2 trend black/blue

UX-69362	black / blue	38-52	S1P	velcro fastener	sandal
UX-69378	black / blue	38-52	S1	lace fastening	low shoe

Safety shoe uvex 2 trend black/red 

Safety shoe; upper micro suede; steel toe cap; suitable for orthopedic insoles; PU/PU outsole; very slip-resistant. EN ISO 20345:2011 S1/S1P SRC
 UX-69078: EN ISO 20345:2011 S1 SRC
 UX-69062: EN ISO 20345:2011 S1P SRC



dpvlink 24281

Article	Color	Size	Category	Closure	Form
---------	-------	------	----------	---------	------

Safety shoe uvex 2 trend black/red

UX-69078	black / red	38-52	S1	lace fastening	low shoe
UX-69062	black / red	38-52	S1P	velcro fastener	sandal

Safety shoe uvex 2 trend black/grey 

Safety shoe; upper micro suede; steel toe cap; suitable for orthopedic insoles; PU/PU outsole; very slip-resistant. EN ISO 20345:2011 S1/S1P SRC
 UX-69478: EN ISO 20345:2011 S1 SRC
 UX-69462: EN ISO 20345:2011 S1P SRC



dpvlink 24282

Article	Color	Size	Category	Closure	Form
---------	-------	------	----------	---------	------

Safety shoe uvex 2 trend black/grey

UX-69462	black / grey	38-52	S1P	velcro fastener	sandal
UX-69478	black / grey	38-52	S1	lace fastening	low shoe

Safety shoe uvex 1 Business 

Safety shoe; upper micro suede; wide steel toe cap; suitable for orthopedic insoles; PU outsole; oil- and benzene-resistant; very slip-resistant. EN ISO 20345:2011 S2 SRC



dpvlink 24244

Article	Color	Size	Category	Upper	Form
---------	-------	------	----------	-------	------

Safety shoe uvex 1 Business

UX-84698	grey	39-52	S2	micro suede	low shoe
----------	------	-------	----	-------------	----------

Safety shoe / safety boot uvex 1 Business blue 

Safety shoe; upper micro suede; steel toe cap; metal-free penetration protection; suitable for orthopedic insoles; PU outsole; oil- and benzene-resistant; very slip-resistant. EN ISO 20345:2011 S3 SRC



dpvlink 24246

Article	Color	Size	Category	Closure	Form
---------	-------	------	----------	---------	------

Safety shoe / safety boot uvex 1 Business blue

UX-84282	blue	39-52	S3	lace fastening	low shoe
UX-84272	blue	39-52	S3	lace fastening	boot

Insoles

Insole ESD 1 Sport



For uvex 1 Sport models

- all-over cushioning of the foot
- highly breathable
- moisture-absorbing
- quick-drying
- antistatic

dpvlink 24254

Article	Type	Size
UX-95798	Insole ESD 1 Sport	35-52



Insole ESD 1 G2



For uvex 1 G2 models

- all-over cushioning of the foot
- highly breathable
- moisture-absorbing
- quick-drying
- antistatic
- hand washing up to 30°C

dpvlink 24250

Article	Type	Size
UX-94908	Insole ESD 1 G2	35-52



Insole ESD 1



For uvex 1 and uvex 2 xenova models

- all-over cushioning of the foot
- highly breathable
- moisture-absorbing
- quick-drying
- perforation for more breathability
- antistatic

dpvlink 24253

Article	Type	Size
UX-95348	Insole ESD 1	35-52



Insole ESD 2 trend



For uvex 2 models

- all-over cushioning of the foot
- highly breathable
- moisture-absorbing
- quick-drying
- antistatic

dpvlink 24335

Article	Type	Size
UX-95188	Insole ESD 2 trend	38-52



Insole ESD 1 Business



For uvex 1 Business models

- all-over cushioning of the foot
- highly breathable
- moisture-absorbing
- antistatic

dpvlink 24252

Article	Type	Size
UX-95158	Insole ESD 1 Business	39-52



Find your shoe quickly and easily!

- Find the appropriate shoe quickly with our **shoe filter** in our **online shop**
- **simple search** in the complete product range of professional and safety shoes
- **many filter criteria** for optimal selection

Use our shoe filter online - with a few clicks to the appropriate shoe!

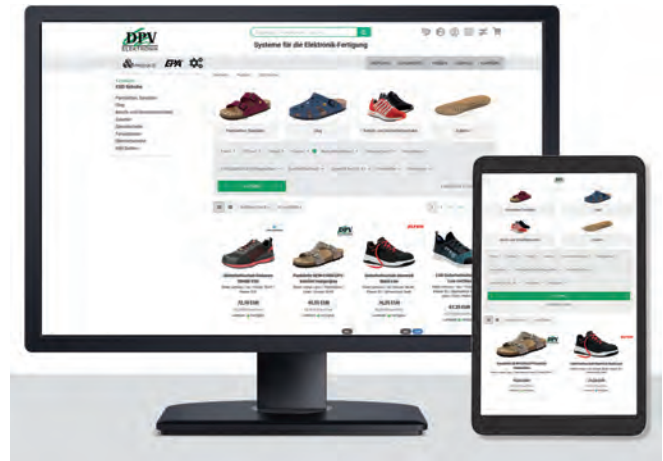

Filter according to the requirements for your shoe:

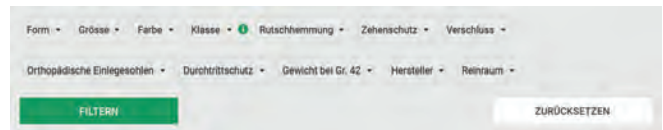

- Manufacturer
- Size
- Color
- Shoe shape
- Professional and safety class
- Slip resistance
- Penetration protection
- Suitability for orthopedic insoles























You will find more information about the requirements directly in the filter.

Filter now and find the appropriate shoe...



PUMA SAFETY products are developed, manufactured and distributed by ISM, a family-run company based in Lippstadt since 1930. As one of the leading sports brand in the world PUMA is endorsed by the fastest athletes in the world. For this reason, the PUMA brand is based on values propelling high-performing athletes to the next level. ISM shares these values and has been cooperating with PUMA since 2002 to develop PUMA SAFETY, a stunning range of high-performance safety shoes with a sporty flair.



-  **ESD approved shoes**
in accordance with EN 61340
-  **Safety shoes S1**
in accordance with EN ISO 20345
-  **Safety shoes S1P**
in accordance with EN ISO 20345
-  **Safety shoes S1PL according to EN ISO 20345:2022**
-  **Safety shoes S3**
in accordance with EN ISO 20345
-  **Safety shoes S3L according to EN ISO 20345:2022**
-  **Steel toe cap**
-  **Metal-free toe cap**
-  **Slip resistance SR according to EN 13287**
-  **Slip resistance SRC**
in accordance with EN 13287
-  **Penetration protection metal-free**
-  **100% metal-free shoe**
-  **Very lightweight shoe**
-  **Vegan shoe**
-  **Exchangeable insole**
-  **DGVU standard 112-191**
Suitable for orthopedic insoles in accordance with DGVU standard 112-191
-  **FAP®**
Flexible anti-penetration: penetration-resistant, non-metallic midsole
-  **SAFETY KNIT®**
Highly flexible textile fabric, fits like a sock
-  **IMPULSE.FOAM®**
Anti-fatigue sole technology for maximal shock absorption, excellent stability and long-lasting comfort
-  **FUUSE.TEC®**
Shoes with seamlessly welded reinforcement elements
-  **3D Triple Density**
Three-sole system with specific functions
-  **Quick Lock**
Quick closure system

Safety shoes

Safety shoe Iconic Suede



Safety shoe; upper made of high-quality suede; fiberglass toe cap; flexible FAP® penetration protection; BreathActive functional lining; Evercushion® RELIEF footbed; rubber outsole oil-, acid and fuel-resistant; antistatic; EN ISO 20345 S1PL



dpvlink 27847

Article	Color	Size	Category
Safety shoe Iconic Suede			
PU-640010	black	36-49	S1PL
PU-640020	blue	39-48	S1PL
PU-640030	grey	36-48	S1PL



Safety shoe Airtwist



Safety shoe; upper made of hydrophobized suede; fiberglass toe cap; TPU heel protection; BreathActive functional lining; EVA intermediate sole; EFFECT.FOAM for excellent cushioning; Evercushion® CUSTOM FIT MID footbed; 3D Triple Density; rubber outsole oil-, acid and fuel-resistant; antistatic; EN ISO 20345 S3



dpvlink 27853

Article	Color	Size	Category	Closure
Safety shoe Airtwist				
PU-644610	grey	39-47	S3	lace fastening
PU-644630	black / red	39-47	S3	lace fastening
PU-644650	black	39-47	S3	lace fastening
PU-644620	blue	39-47	S3	lace fastening
PU-644651	black	39-47	S3	Quick Lock



Safety shoe Frontside Low



Safety shoe; upper made of mesh with microfiber; fiberglass toe cap; TPU heel protection; BreathActive functional lining; EVA midsole; EFFECT.FOAM for excellent cushioning; Evercushion® CUSTOM FIT MID footbed; 3D Triple Density; rubber outsole oil-, acid and fuel-resistant; antistatic; EN ISO 20345 S1P



dpvlink 27856

Article	Color	Size	Category
Safety shoe Frontside Low			
PU-644640	blue / grey	39-47	S1P
PU-644670	brown / ivy	39-47	S1P
PU-644660	black / blue	39-47	S1P

Safety shoe Frontcourt



Safety shoe; upper made of smooth leather; fiberglass toe cap; idCell elements in the heel and forefoot for optimal shock absorption; flexible FAP® penetration protection; BreathActive functional lining; Evercushion® RELIEF footbed; rubber outsole with integrated rotation point; oil-, acid and fuel-resistant; antistatic; EN ISO 20345 S3L SR



dpvlink 27859

Article	Color	Size	Category
Safety shoe Frontcourt			
PU-630050	black / red	36-49	S3L
PU-630070	blue / black	39-48	S3L
PU-640200	black / red	39-48	S3L

Safety shoe Charge Orange / Green / Black Low



Safety shoe; upper SAFETY KNIT®; fiberglass toe cap; TPU protection in the toe and heel area; microfiber functional lining; metal-free; rubber outsole; oil-, acid and fuel-resistant; antistatic; EN ISO 20345 S1P HRO SRC



dpvlink 27318

Article	Color	Size	Category
Safety shoe Charge Orange / Green / Black Low			
PU-644550	black / orange	36-47	S1P
PU-644520	blue / green	36-47	S1P
PU-644540	black / grey	36-47	S1P

Safety shoe Charge Black Disc Low



Safety shoe; SAFETY KNIT® upper; TPU protection in the toe and heel area; fiberglass toe cap; microfiber lining; IMPULSE.FOAM®; ; metal-free; rubber outsole; outsole oil-, acid and fuel-resistant; antistatic; EN ISO 20345 S1P HRO SRC



dpvlink 27561

Article	Color	Size	Category
Safety shoe Charge Black Disc Low			
PU-644541	grey	36-47	S1P

Safety shoe Aviat Low



Safety shoe; upper microfiber with TPU reinforcement; steel toe cap; flexible FAP® penetration protection; breathable functional lining; EFFECT.FOAM for excellent shock absorption; PU outsole; oil-, acid and fuel-resistant; antistatic; EN ISO 20345 HRO S1P



dpvlink 26891

Article	Color	Size	Category
Safety shoe Aviat Low			
PU-640891	black / red	39-47	S1P

Safety shoe Fuse Knit Blue / Black WNS Low



Safety shoe; upper SAFETY KNIT®; fiberglass toe cap; flexible FAP® penetration protection; microfiber functional lining; metal-free; 3D Triple Density; rubber outsole; oil-, acid and fuel-resistant; antistatic; EN ISO 20345 S1P HRO SRC



dpvlink 27315

Article	Color	Size	Category
Safety shoe Fuse Knit Blue / Black WNS Low			
PU-643900	grey / blue	36-42	S1P
PU-643930	black / blue	36-42	S1P

Safety shoe Beat WNS Low



Safety shoe; mesh upper; fiberglass toe cap; TPU protection in the toe and heel area; microfiber functional lining; 3D Triple Density; rubber outsole, oil-, acid and fuel-resistant; antistatic; EN ISO 20345 S1 HRO SRC



dpvlink 27311

Article	Color	Size	Category
Safety shoe Beat WNS Low			
PU-643910	blue	36-42	S1



Safety shoe Define WNS Low



Safety shoe; upper SAFETY KNIT®; fiberglass toe cap; TPU protection in the toe and heel area; microfiber functional lining; 3D Triple Density; rubber outsole; outsole oil-, acid and fuel-resistant; antistatic; EN ISO 20345 S1P HRO SRC



dpvlink 27313

Article	Color	Size	Category
Safety shoe Define WNS Low			
PU-643920	black / purple	36-42	S1P



Safety shoe Velocity 2.0 Blue Low



Safety shoe; upper made of durable microfiber with TPU reinforcement; fiberglass toe cap; IMPULSE.FOAM®; flexible FAP® penetration protection; microfiber functional lining; metal-free; 3D Triple Density; rubber outsole, oil-, acid- and fuel-resistant; antistatic.

EN ISO 20345 HRO S1P



dpvlink 26528

Article	Color	Size	Category
Safety shoe Velocity 2.0 Blue Low			
PU-643850	blue	36-48	S1P



Safety shoes Fuse Motion 2.0 Red / Green Low



Safety shoe; mesh upper; FUSE.TEC elements (seamless applied reinforcing elements); fiberglass toe cap; flexible FAP® penetration protection; microfiber functional lining; metal-free; rubber outsole; oil-, acid- and fuel-resistant; antistatic; EN ISO 20345 HRO S1P



dpvlink 26525

Article	Color	Size	Category
Safety shoes Fuse Motion 2.0 Red / Green Low			
PU-643890	black / red	39-48	S1P
PU-643880	grey / green	39-48	S1P



Safety shoes Elevate Knit Green / Black Low



Safety shoe; upper SAFETY KNIT®; fiberglass toe cap; flexible FAP® penetration protection; microfiber functional lining; metal-free; rubber sole; TPU protection in the toe and heel area; outsole oil-, acid- and fuel-resistant; antistatic. EN ISO 20345 HRO S1P



dpvlink 26520

Article	Color	Size	Category
Safety shoes Elevate Knit Green / Black Low			
PU-643160	black / grey	39-47	S1P
PU-643170	blue / green	39-47	S1P



Safety shoe Vivid GH Low



Safety shoe; SAFETY KNIT® upper; fiberglass toe cap; microfiber functional lining; metal-free; rubber outsole; tightening loop for easier putting on; FAP Green; outsole oil-, acid and fuel-resistant; antistatic; EN ISO 20345 HRO S1P



dpvlink 27563

Article	Color	Size	Category
Safety shoe Vivid GH Low			
PU-643050	black / blue	40-47	S1P



Safety shoe Fuse TC Green Low



Safety shoe; microfiber upper with breathable mesh; FUSE.TEC elements (seamless applied reinforcing elements); fiberglass toe cap; flexible FAP® penetration protection; microfiber functional lining; metal-free; PU/PU outsole, oil-, acid- and fuel-resistant; antistatic; EN ISO 20345 HRO S1P



dpvlink 26532

Article	Color	Size	Category	Closure
Safety shoe Fuse TC Green Low				
PU-644210	black / green	40-49	S1P	lace fastening
PU-644211	black / green	40-48	S1P	Quick Lock

Safety sandal Neodyme Low



Safety sandal; microfiber upper with breathable mesh; fiberglass toe cap; flexible FAP® penetration protection; microfiber functional lining; metal-free; PU/PU outsole, oil-, acid- and fuel-resistant; antistatic; EN ISO 20345 S1P



dpvlink 26885

Article	Color	Size	Category
Safety sandal Neodyme Low			
PU-644300	black / green	40-49	S1P

Safety shoe Fuse TC Pink WNS Low



Safety shoe; microfiber upper with breathable mesh; FUSE.TEC elements (seamless applied reinforcing elements); steel toe cap; toe protection; flexible FAP® penetration protection; microfiber functional lining; metal-free; PU/PU outsole oil-, acid and fuel-resistant; antistatic; EN ISO 20345 S1P



dpvlink 26887

Article	Color	Size	Category
Safety shoe Fuse TC Pink WNS Low			
PU-644110	black / rose	36-42	S1P

Insoles

Insole EVERCUSHION®



- extremely breathable
- adapts perfectly to the foot
- very good shock absorption
- antibacterial textile surface

dpvlink 26594

Article	Type	Size
PU-204500	Insole EVERCUSHION®	39-47



ESD



ALBATROS® is one of the leading German brands for performance safety shoes. All ALBATROS® products are designed and developed by an international team of PPE experts in German. For more than 40 years ALBATROS® has been constantly improving the quality, comfort, functionality and design of its products - to support professionals during their work.



ESD approved shoes
in accordance with EN 61340

01 Work shoes 01
in accordance with EN ISO 20347

S1 Safety shoes S1
in accordance with EN ISO 20345

S1P Safety shoes S1P
in accordance with EN ISO 20345

Metal-free toe cap

Slip resistance SRA
in accordance with EN 13287

Slip resistance SRC
in accordance with EN 13287

Penetration protection metal-free

100% metal-free shoe

Very lightweight shoe

Vegan shoe

DGUV standard 112-191
Suitable for orthopedic insoles in accordance with DGUV standard 112-191

FAP®
Flexible anti-penetration: penetration-resistant, non-metallic midsole

SAFETY KNIT®
Highly flexible textile fabric, fits like a sock

IMPULSE.FOAM®
Anti-fatigue sole technology for maximal shock absorption, excellent stability and long-lasting comfort

3D Triple Density
Three-sole system with specific functions

Quick Lock
Quick closure system

Safety shoes

Safety shoe TWISTER DY Navy Low

Safety shoe; upper made of high-quality suede with durable mesh elements; fiberglass toe cap; reflective elements; flexible FAP® penetration protection; breathable functional lining; metal-free; DUO PU outsole oil-, acid and fuel-resistant; antistatic; EN ISO 20345 S1P



dpvlink 27871

Article	Color	Size	Category	Closure
Safety shoe TWISTER DY Navy Low				
AL-648800	blue	36-47	S1P	lace fastening



Safety shoe Rider Black Low

Safety shoe; upper made of microfiber in carbon look with durable mesh; fiberglass toe cap; flexible FAP® penetration protection; breathable functional lining; metal-free; DUO PU outsole oil-, acid and fuel-resistant; antistatic; EN ISO 20345 S1P



dpvlink 27873

Article	Color	Size	Category	Closure
Safety shoe Rider Black Low				
AL-648790	black	36-47	S1P	lace fastening



Safety shoe FORGE AIR Black/Blue Low

Very lightweight safety shoe; upper made of durable microfiber; heel and midfoot support; fiberglass toe cap; flexible FAP® penetration protection; evercushion® RELIEF footbed; breathable functional lining; metal-free; EFFECT.FOAM® for excellent cushioning; DUO PU/TPU outsole oil-, acid and fuel-resistant; antistatic; EN ISO 20345 S1



dpvlink 27875

Article	Color	Size	Category	Closure
Safety shoe FORGE AIR Black/Blue Low				
AL-648060	black / blue	38-48	S1	lace fastening



Safety shoe FASTPACK Black/Blue Low  

Very lightweight safety shoe; upper made of durable microfiber with breathable mesh elements; heel and midfoot support; fiberglass toe cap; flexible FAP® penetration protection; evercushion® RELIEF footbed; breathable functional lining; metal-free; EFFECT.FOAM® for excellent cushioning; DUO PU/TPU outsole oil-, acid and fuel-resistant; antistatic; EN ISO 20345 S1PL



dpvlink 27877



Article	Color	Size	Category
Safety shoe FASTPACK Black/Blue Low			
AL-648040	black / blue	39-48	S1PL

Safety shoe TARAVAL Black/Blue Low  

Very lightweight safety shoe; upper made of durable microfiber; heel and midfoot support; fiberglass toe cap; flexible FAP® penetration protection; evercushion® RELIEF footbed; breathable functional lining; metal-free; EFFECT.FOAM® for excellent cushioning; DUO PU/TPU outsole oil-, acid and fuel-resistant; antistatic; EN ISO 20345 S3L



dpvlink 27879



Article	Color	Size	Category
Safety shoe TARAVAL Black/Blue Low			
AL-648030	black / blue	39-48	S3L

Safety shoe JETSTREAM Impulse Low  

Safety shoe; upper made of durable microfiber with wear-resistant textile elements; padded leg end and flap; fiberglass toe cap; anatomically shaped comfit® AIR insole; breathable functional lining; metal-free; IMPULSE.FOAM® midsole for excellent cushioning; DUAL.IMPULSE rubber outsole oil-, acid and fuel-resistant; antistatic; EN ISO 20345 S1



dpvlink 27881



Article	Color	Size	Category
Safety shoe JETSTREAM Impulse Low			
AL-647530	black / blue	36-47	S1

Safety shoe LIFT Red Impulse Low  

Safety shoe; upper made of durable 3D textile fabric with FITFRAME® elements; padded leg edge and flap; fiberglass toe cap; anatomically shaped comfit® AIR insole; breathable functional lining; metal-free; flexible FAP® penetration protection; IMPULSE.FOAM® midsole for excellent cushioning; 3D Triple Density; DUAL.IMPULSE rubber outsole oil-, acid and fuel-resistant; antistatic; EN ISO 20345 S1P



dpvlink 27883



Article	Color	Size	Category
Safety shoe LIFT Red Impulse Low			
AL-646600	black / rose	39-47	S1P

Safety shoe AER55 Impulse Black Blue Low  

Very light safety shoe; SAFETY KNIT® upper with FITFRAME® elements (seamless applied reinforcing elements); composite toe cap; TPU protection in the toe and heel area; flexible FAP® penetration protection; breathable functional lining; DUAL.FOAM® midsole; 3D Triple Density; metal-free; outsole oil-, acid and fuel-resistant; antistatic; EN ISO 20345 S1P



dpvlink 26537



Article	Color	Size	Category	Closure
Safety shoe AER55 Impulse Black Blue Low				
AL-647502	black / blue	36-47	S1P	Quick Lock
AL-647500	black / blue	36-47	S1P	lace fastening

Safety shoe AER55 Impulse Blue Orange Low  

Very light safety shoe; SAFETY KNIT® upper with FITFRAME® elements (seamless applied reinforcing elements); fiberglass toe cap; TPU protection in the toe and heel area; flexible FAP® penetration protection; breathable functional lining; DUAL.FOAM® midsole; metal-free; outsole oil-, acid and fuel-resistant; antistatic; EN ISO 20345 S1P



dpvlink 26882



Article	Color	Size	Category	Form	Closure
AL-647510	blue / orange	36-47	S1P	low shoe	lace fastening

Safety shoe BREEZE Impulse Low 

Very light safety shoe; mesh upper; fiberglass toe cap; TPU protection in the toe and heel area; flexible FAP® penetration protection; breathable functional lining; DUAL.FOAM® midsole; metal-free; 3D Triple Density; outsole oil-, acid and fuel-resistant; antistatic; EN ISO 20345 S1P



dpvlink 26539

Article	Color	Size	Category	Closure
Safety shoe BREEZE Impulse Low				
AL-647520	black / blue	36-47	S1P	quick-release fastener
AL-647528	black / blue	36-47	S1P	Quick Lock

Safety shoe AER58 Blue Low 

Safety shoe; textile upper with microfiber and TPU reinforcement; fiberglass toe cap; flexible FAP® penetration protection; breathable functional lining; rubber sole; metal-free; outsole oil-, acid and fuel-resistant; antistatic; EN ISO 20345 HRO S1P



dpvlink 26544

Article	Color	Size	Category	Form	Closure
AL-647660	blue / grey	39-48	S1P	low shoe	lace fastening

Safety shoe ESD Court Blue / Sand / Grey 

SAFETY KNIT® upper; breathable functional lining; anatomically shaped comfit®AIR insole; fiberglass toe cap; metal-free, flexible FAP® penetration protection; tightening loop for easier putting on, ESD, metal-free; DUAL.IMPULSE sole; 3D Triple Density; outsole oil-, acid and fuel-resistant; antistatic; EN ISO 20345 S1P HRO SRC



dpvlink 27556

Article	Color	Size	Category	Closure
Safety shoe ESD Court Blue / Sand / Grey				
AL-647640	blue	39-48	S1P	lace fastening
AL-647610	sand	39-48	S1P	lace fastening
AL-647630	grey	39-48	S1P	lace fastening

Safety shoe AER58 Green Low 

Safety shoe; textile upper with microfiber and TPU reinforcement; fiberglass toe cap; flexible FAP® penetration protection; breathable functional lining; rubber sole; metal-free; 3D Triple Density; outsole oil-, acid and fuel-resistant; antistatic; EN ISO 20345 HRO S1P



dpvlink 26883

Article	Color	Size	Category	Form	Closure
AL-647650	green / black	39-48	S1P	low shoe	lace fastening

Safety shoe Voltage Black QL Low 

Safety shoe; textile upper; fiberglass toe cap; flexible penetration protection; breathable functional lining; rubber sole; metal-free; Quick Lock closure; 3D Triple Density; outsole oil-, acid and fuel-resistant; antistatic; EN ISO 20345 HRO S1P



dpvlink 27209

Article	Color	Size	Category	Form	Closure
AL-647670	black	39-48	S1P	low shoe	Quick Lock

Safety shoes Blue Impulse Low 

Very light safety shoe; SAFETY KNIT® upper with FITFRAME® elements (seamless applied reinforcing elements); fiberglass toe cap; TPU protection in the toe and heel area; flexible FAP® penetration protection; breathable functional lining; DUAL.FOAM midsole; metal-free; 3D Triple Density; outsole oil-, acid and fuel-resistant; antistatic; EN ISO 20345 S1P



dpvlink 26541

Article	Color	Size	Category	Form	Closure
AL-646610	blue / black	39-47	S1P	low shoe	lace fastening

Safety shoe Splendid Green GH Low  

Safety shoe made of recycled PET bottles; SAFETY KNIT® Green upper; fiber glass toe cap; flexible FAP® Green penetration protection; breathable functional lining; metal-free; outsole oil-, acid and fuel-resistant; antistatic; EN ISO 20345 S1P HRO



dpvlink 26608

Article	Color	Size	Category	Form	Closure
AL-646300	black / green	36-47	S1P	low shoe	lace fastening



Professional shoes AER55 ST Blue /  
Black / White Low

Professional shoe; SAFETY KNIT® upper with FITFRAME® elements (seamless applied reinforcing elements); padded leg and tongue; TPU protection in the toe and heel area; breathable functional lining; metal-free; 3D Triple Density; rubber outsole oil-, acid and fuel-resistant; antistatic; EN ISO 20345 O1 SRA



dpvlink 26546

Article	Color	Size	Category	Form	Closure
AL-654940	black / blue	36-47	O1	low shoe	lace fastening
AL-654950	blue	41-47	O1	low shoe	lace fastening
AL-654900	black	36-47	O1	low shoe	lace fastening
AL-654910	white	36-42	O1	low shoe	lace fastening



Insoles

Insole COMFIT®AIR  



- shock-absorbing elevations in the heel and the ball area
- longitudinal arch support
- slip-resistant textile surface
- antibacterial textile surface

dpvlink 26596

Article	Type	Size
AL-204750	Insole COMFIT®AIR	36-47



Find a clear and simple presentation of our wide range of products online.



Numerous **store advantages** are waiting for you!

Your online shop benefits at a glance:

- Multi-user administration
- Customer-specific pricing
- Germany-wide deliveries from 250 € free of shipping costs with DHL GoGreen
- Individual solutions via our online configurators
- Customized eProcurement solutions
- Customer-specific catalogs
- Comparison lists
- Knowledge media library

Always up to date with our

newsletter!

Register now in the online shop!





LEMAITRE

meisterhafte Sicherheitsschuhe

Lemaitre creates extraordinary sole structures, designs and fits and more than 30 years of experience are put in every shoe.

Diversity, individuality and uncompromising technology are a must. LEMAITRE patents contribute to most different solutions and keep product innovations at hand that are considered to be spectacular and trendsetting. Competence and experience provide a complete product range of safety shoes for qualitative "foot work" valid according to EN standards.

Wearing LEMAITRE safety shoes the boundaries between work and leisure become blurred.



Logo

You want to emphasize the company affiliation of your employees?

Have your safety shoes equipped with your company logo, and that from 1 pair!

Your motive will be printed on a surface of up to 60 x 20mm with a resolution of 300 ppi. No matter if unicolored, multicolored or as reflection version! Simply contact us and send us a vector graphic with you motive!

Printing on the **models**:

- BOLT (LE-8095)
- RILEY LOW (LE-8061)
- IVAR (LE-8105)
- ADRIAN (LE-8104)
- MICHEL LOW (LE-8106)
- MILO (LE-8108)



ESD approved shoes
in accordance with EN 61340



Safety shoes S1P
in accordance with EN ISO 20345



Safety shoes S3
in accordance with EN ISO 20345



Steel toe cap



Aluminum toe cap



Slip resistance SRC
in accordance with EN 13287



Penetration protection metal-free



Exchangeable insole



DGUV standard 112-191
Suitable for orthopedic insoles in accordance with DGUV standard 112-191

Safety shoes

Safety shoe Riley Light

LEMAITRE

Safety shoe; upper microfiber, lace fastening; aluminum toe cap; metal-free penetration protection; mesh lining; PU outsole; suitable for orthopedic insoles DGUV 112-191; oil-, acid- and fuel-resistant; slip-resistant; antistatic. EN ISO 20345:2011 S1P SRC



dpvlink 25081



Article	Color	Size	Category	Closure
Safety shoe Riley Light				
LE-8058	black / red	35-49	S1P	lace fastening

Safety shoe Riley Low / Riley Fresh / Riley High

LEMAITRE

Safety shoe; upper seamless microfiber; aluminum toe cap; metal-free penetration protection; mesh lining; PU outsole; DGUV 112-191; oil-, acid- and fuel-resistant; slip-resistant; antistatic. EN ISO 20345:2011 (personalization possible with LE-8061)



dpvlink 23536



Article	Color	Size	Category	Form	Closure
Safety shoe Riley Low / Riley Fresh / Riley High					
LE-8061	black / red	36-49	S3	low shoe	lace fastening
LE-8060	black / red	36-49	S1P	sandal	velcro fastener
LE-8062	black / red	36-49	S3	boot	lace fastening

Safety shoe Lennon

LEMAITRE

Safety shoe; upper breathable textile; aluminum toe cap; metal-free penetration protection; textile 3D mesh lining; PU outsole; suitable for orthopedic insoles DGUV 112-191; oil-, acid- and fuel-resistant; slip-resistant; antistatic. EN ISO 20345:2011 S1P SRC



dpvlink 25083



Article	Color	Size	Category	Closure
Safety shoe Lennon				
LE-8082	black	35-49	S1P	lace fastening

Safety shoe Paul / Harrison / Ringo LEMAITRE 

Safety shoe; upper microfiber/PU TEK®; aluminum toe cap; metal-free penetration protection; breathable 3D mesh lining; shock protection on the foot tip; PU outsole; oil-, acid- and fuel-resistant; slip-resistant; antistatic. EN ISO 20345:2011 S3 SRC



dpvlink 24800

Article	Color	Size	Category	Closure	Upper
Safety shoe Paul / Harrison / Ringo					
LE-8075	black / blue	35-49	S3	lace fastening	microfiber
LE-8078	black / yellow	35-49	S3	UTURN®	microfiber
LE-8076	black / green	35-49	S3	lace fastening	Putek®



Safety shoe Bolt LEMAITRE 

Safety shoe; upper microfiber; steel toe cap; metal-free penetration protection; abrasion-resistant lining; PU outsole; suitable for orthopedic insoles (DGVU 112-191); oil-, acid- and fuel-resistant; slip-resistant, antistatic. EN ISO 20345:2011 S3 SRC (personalization possible with LE-8095)



dpvlink 23543

Article	Color	Size	Category	Closure
Safety shoe Bolt				
LE-8095	black	36-48	S3	lace fastening



Safety shoe Space Blue LEMAITRE 

Safety shoe; upper textile with suede; aluminum toe cap; metal-free penetration protection; abrasion-resistant textile lining; PU outsole; suitable for orthopedic insoles; oil-, acid- and fuel-resistant; slip-resistant; antistatic. EN ISO 20345:2011 S3 SRC



dpvlink 23540

Article	Color	Size	Category	Form
Safety shoe Space Blue				
LE-1985	black / blue	38-48	S3	low shoe



Safety shoe Ohmex / Faye LEMAITRE 

Safety shoe; upper microfiber with perforations; aluminum toe cap; abrasion-resistant textile lining; PU outsole; oil-, acid- and fuel-resistant; slip-resistant; antistatic. EN ISO 20345:2011 S1 SRC

Model **Ohmex** (LE-8080) additionally with sporty, flexible TPU tip protection extending the shelf life with kneeling work and external impacts.



dpvlink 24801

Article	Color	Size	Category
Safety shoe Ohmex / Faye			
LE-8080	black	36-48	S1P men
LE-8081	grey	36-43	S1P women



Safety shoes Super X Fresh / Super X Low / Super X High LEMAITRE 

Safety shoe; upper buffalo nubuck, reflecting appliques, steel toe cap; metal-free penetration protection; mesh lining; PU outsole; suitable for orthopedic insoles (DGVU 112-191); oil-, acid- and fuel-resistant; slip-resistant; antistatic.

Super X Fresh LE-1260 EN ISO 20345:2011 S1P SRC
Super X Low LE-1261 and Super X High LE-1262 EN ISO 20345:2011 S3 SRC



dpvlink 23340

Article	Color	Size	Category	Form	Closure
Safety shoes Super X Fresh / Super X Low / Super X High					
LE-1260	black / red	35-48	S1P	sandal	velcro fastener
LE-1261	black / red	35-48	S3	low shoe	lace fastening
LE-1262	black / red	35-48	S3	boot	lace fastening



Safety shoe Ivar / Adrian LEMAITRE 

Safety shoe; microfiber upper with TPU coating and water-repellent textile; aluminum toe cap; breathable mesh lining; PU/PU outsole; oil-, acid- and fuel-resistant; slip-resistant; antistatic; EN ISO 20345:2011 S3 SRC (personalization possible)



dpvlink 27291

Article	Color	Size	Category
Safety shoe Ivar / Adrian			
LE-8104	black	35-49	S3
LE-8105	grey / black	35-49	S3



Safety shoe Wiki / Mads

LEMAITRE

Safety shoe; perforated upper of textile and leather: aluminum toe cap; wear-resistant textile lining; PU/PU outsole: oil-, acid- and fuel-resistant; slip-resistant; antistatic. EN ISO 20345:2011 S1P SRC



dpvlink 27281



Article	Color	Size	Category	Form
Safety shoe Wiki / Mads				
LE-8102	blue	35-49	S1P	low shoe
LE-8101	blue	35-49	S1P	boot
LE-8103	blue / black	35-49	S1P	low shoe

Safety shoe Michel / Nils / Milo

LEMAITRE

Safety shoe; microfiber upper with TPU coating and water-repellent textile; LE-8109 + LE-8110 with perforated upper; aluminum toe cap; mesh lining; PU/PU outsole; oil-, acid- and fuel-resistant; slip-resistant; antistatic; EN ISO 20345:2011 SRC (personalization possible with LE-8106 and 8108)



dpvlink 27284



Article	Color	Size	Category	Closure
Safety shoe Michel / Nils / Milo				
LE-8109	black / blue	35-49	S1P	lace fastening
LE-8106	black / blue	35-49	S3	lace fastening
LE-8110	black / blue	35-49	S1P	UTURN®
LE-8108	black / blue	35-49	S3	UTURN®

Insoles

Insole Titan

LEMAITRE



- antistatic insole suitable for all Lemaitre shoes
- extremely high breathability
- adapts perfectly to the foot
- shock-absorbing with additional heel cushioning
- quick drying

dpvlink 25750



Article	Type	Size
Insole Titan		
LE-9907	Insole Titan with memory foam	35-50

STEITZ SECURA
SICHERHEITSSCHUHE

HIGH-TECH FOR YOUR FEET

Our shoes have reduced leverage as well as multi-zone and heel absorption. That is the foundation. Added to this are special features for various occupations. Because every job presents different requirements for safety shoes. That is why we have such a great variety of models: safety shoes for all-round use, heavy-duty models with optional mid-foot protection and protection against electrostatic discharge, special shoes for foundrymen and welders, our firefighter collection, the women's line specially designed for women's feet and much more.



SECURA VARIO® SYSTEM

BACK PROTECTION THANKS TO INDIVIDUAL HEEL SHOCK ABSORPTION

Customized shock absorption: the replaceable, weight- and pressure-dependent heel shock absorption system ensures cushioning adapted to the individual needs of the wearer. The pressure load in the shoe is reduced to a natural extent and provides targeted relief to the back. At the same time, it helps to relieve the back in a targeted way and to significantly reduce fatigue. Models for women have the heel cushioning yellow (up to 57 kg) and green (up to 79 kg). Unisex models sizes 35-44 have the heel cushioning green (up to 79 kg) and red (up to 91 kg) or for the sizes 45-50 in red (up to 91 kg) and black (up to 105 kg).



CLIMATE COMFORT

NOT TOO COLD, NOT TOO WARM, JUST RIGHT

















A perfect climate for your feet: With the climate comfort concept, we make sure that you will feel comfortable in your shoes for many hours. We only use climate- and skin-friendly materials to provide a pleasant-to-wear sensation. We use Gore-Tex as an effective climate-membrane. Inside the shoe you will find the heart of the STEITZ climate comfort concept, the leather insole. The sole made of genuine, vegetable-tanned leather with skin-friendly pH-value adapts individually to the foot. It also stores humidity that is carried away from the foot through our insoles. This prevents heat build-up and unpleasant sweating inside the shoe.



VARIO MULTIFLEX®

GET THE FEEL OF BAREFOOT WALKING

Many safety shoes influence the natural movement of the foot and limit its flexibility. The resulting leverage forces cause knee pain and back problems and can result in twisted ankles. That won't happen with us! Through intelligent adjustments to the shoe, we reduce undesired leverage forces: for example, by modifying the geometry of the outsole or reducing the sole thickness. One result of the VARIO Multiflex® technology is the multi-flexible sole.

-  **ESD approved shoes**
in accordance with EN 61340
-  **Safety shoes S1**
in accordance with EN ISO 20345
-  **Safety shoes S2**
in accordance with EN ISO 20345
-  **Aluminum toe cap**
-  **Metal-free toe cap**
-  **Slip resistance SRC**
in accordance with EN 13287
-  **100% metal-free shoe**
-  **Very lightweight shoe**
-  **Seamless finishing**
Footwear without any seams
-  **Vegan shoe**
-  **Exchangeable insole**
-  **DGVU standard 112-191**
Suitable for orthopedic insoles in accordance with DGVU standard 112-191
-  **BOA® closure system**
for an easy fitting of the shoe
-  **SECURA VARIO® system**
weight-adapted heel shock absorption
-  **VARIO MULTIFLEX®**
Shoe construction with reduced lever arm forces supporting the natural movement of the feet
-  **Genuine leather insole**
Unique shoe climate

Safety shoes

Safety shoe Salix / Pinus



Safety shoe; mesh upper; metal-free toe cap; breathable functional lining; comfort insole with shock-absorption and excellent moisture absorption; outsole TPU Competition ESD; EN ISO 20345:2011 S1 SRC



dpvlink 27269



Article	Color	Size	Category	Closure
Safety shoe Salix / Pinus				
SZ-GL60	black / grey	36-47	S1	lace fastening
SZ-GL61	grey / white	36-47	S1	lace fastening

Safety shoe Robinia / Tilia



Safety shoe; mesh upper; metal-free toe cap; breathable functional lining; comfort insole with shock-absorption and excellent moisture absorption; outsole TPU Competition ESD; EN ISO 20345:2011 S1 SRC



dpvlink 27272



Article	Color	Size	Category	Closure
Safety shoe Robinia / Tilia				
SZ-GL62	orange	35-42	S1	lace fastening
SZ-GL63	rose / white	35-42	S1	lace fastening

Safety shoe CP 4400 / 4410 / 4480



Safety shoe; seamless upper; metal-free toe cap; breathable functional lining; comfort insole with shock-absorption and excellent moisture absorption; outsole TPU Competition ESD; EN ISO 20345:2011 S1 SRC



dpvlink 27277



Article	Color	Size	Category	Closure
Safety shoe CP 4400 / 4410 / 4480				
SZ-CP4400	blue / white	36-47	S1	lace fastening
SZ-CP4410	blue / orange	36-47	S1	lace fastening
SZ-CP4480	grey / yellow	36-47	S1	lace fastening

Safety sandal VD Pro 1000



Safety sandal; ultra-light microfiber combined with perforated design for optimal ventilation; velcro fastener; shaft appliqué; aluminum toe cap; breathable functional lining; leather-insole; comfort insole with shock-absorption and excellent moisture absorption; outsole: TPU Athletic ESD; EN ISO 20345:2011 S1 SRC



dpvlink 22646

Article	Color	Size	Category	Closure
Safety sandal VD Pro 1000				
SZ-VD1060	black / red	36-47	S1	velcro fastener
SZ-VD1000	black / blue	36-47	S1	velcro fastener
SZ-VD1010	black / grey	36-47	S1	velcro fastener

Safety shoe VD Pro 1100



Safety shoe; ultra-light microfiber, with large perforations; dust flap; tip protection; shaft appliqué; aluminum toe cap; breathable functional lining; leather insole; comfort insole with shock-absorption and excellent moisture absorption; outsole: TPU Athletic ESD; EN ISO 20345:2011 S1 SRC



dpvlink 22656

Article	Color	Size	Category
Safety shoe VD Pro 1100			
SZ-VD1100	black / blue	36-47	S1

Safety shoe VD Pro 1200



Safety shoe; ultra-light microfiber, large perforations; dust flap; tip protection; shaft appliqué; aluminum toe cap; breathable functional lining; leather insole; comfort insole with shock-absorption and excellent moisture absorption; outsole: TPU Athletic ESD; EN ISO 20345:2011 S1 SRC



dpvlink 22662

Article	Color	Size	Category
Safety shoe VD Pro 1200			
SZ-VD1200	black / blue	36-47	S1

Safety shoe VD Pro 1400



Safety shoe; ultra-light microfiber combined with perforations; aluminum toe cap; breathable functional lining; leather insole; comfort insole with shock-absorption and excellent moisture absorption; outsole: TPU Athletic ESD; EN ISO 20345:2011 S1 SRC



dpvlink 22645

Article	Color	Size	Category
Safety shoe VD Pro 1400			
SZ-VD1410	black / grey	36-47	S1
SZ-VD1400	black / blue	36-47	S1
SZ-VD1460	black / red	36-47	S1

Safety shoe Ginger



Women's safety shoe; breathable functional textile with and hexagon-optics; leg appliqué, aluminum toe cap; breathable functional lining; leather insole; comfort insole with shock-absorption and excellent moisture absorption; outsole: TPU Women Sport ESD; EN ISO 20345:2011 S2 SRC



dpvlink 22673

Article	Color	Size	Category
Safety shoe Ginger			
SZ-WG80	black	35-42	S2

Safety shoe Frieda/Carla/Ella



Safety shoe; ultra-light microfiber combined with large ventilation structure; aluminum toe cap; breathable functional lining; genuine leather insole, comfort insole with shock-absorption and excellent moisture absorption; outsole: TPU Woman Sport ESD; EN ISO 20345:2011 S1 SRC



dpvlink 23756

Article	Color	Size	Category	Closure
Safety shoe Frieda/Carla/Ella				
SZ-W125	blue / white	35-42	S1	elastic
SZ-W105	blue / white	35-42	S1	velcro fastener
SZ-W135	blue / white	35-42	S1	lace fastening

Safety sneaker CP 41



Safety shoe; ultra-light microfiber; mesh element; composite toe cap; TPU tip protection; breathable functional lining; comfort insole with shock-absorption and excellent moisture absorption; suitable for orthopedic insoles; outsole TPU Competition ESD; TPU heel edging; EN ISO 20345:2011 SRC



dpvlink 23746

Article	Color	Size	Category	Closure
Safety sneaker CP 41				
SZ-CP4100B	black / red	36-47	S1	Boa®
SZ-CP4310	black	36-47	S2	Boa®
SZ-CP4100	black / red	36-47	S1	lace fastening
SZ-CP4390	grey / yellow	36-47	S2	lace fastening

Safety sneaker CP 43



Safety shoe; textile with high-frequency impression; composite toe cap; reinforced TPU tip protection; breathable functional lining; seamless; comfort insole with shock-absorption and excellent moisture absorption; outsole TPU Competition ESD; TPU heel edging; metal-free; EN ISO 20345:2011 S2 SRC



dpvlink 23741

Article	Color	Size	Category
Safety sneaker CP 43			
SZ-CP4360	red / black	36-47	S2
SZ-CP4300	black / white	36-47	S2

Insoles

Insole Ergo-Soft ESD



- comfortable insole made of soft foam
- support of the cushioning over the entire running surface
- provides pleasant wearing comfort

dpvlink 25752

Article	Type	Size
Insole Ergo-Soft ESD		
SZ-Z25400	Insole Ergo-Soft ESD	35-52



EPApro® ESD Personal Grounding Control System

The innovative EPApro® complete solution for your ESD-protected work areas combines user-friendly precision hardware with a future-oriented software solution for measuring your ESD safety equipment as well as convenient and standard-compliant documentation and central management of the data collected. Multifunctional EPApro® interfaces and control outputs enable simple integration into your company's existing infrastructure.



Advantages of the EPApro® ESD Personnel Tester 1000

- Simple and intuitive operation
- Data logging in compliance with GDPR
- Paperless and low administration
- Integrated Multi RFID reader
- Multilingual
- Only one central server required
- Employee groups
- Several testers can be networked
- Centralized recording and archiving of measured data
- Simple import of employee master data
- For use with access control systems





The long experience gained in more than 60 years of production, combined with a constant research in innovative technologies and materials, allows **FTG an unparalleled development** and production.

FTG is able to satisfy **highest requirements**, covering the most varied environments of use.

A modern production site equipped with a system of the latest generation turns FTG into a reliable business partner capable of producing a wide range of safety shoes to satisfy all needs.

Our values guarantee safety.



In compliance with the ESD standard DIN EN 61340-5-1

We have designed our models in such way that they are very lightweight. Experiments and innovations in manufacturing allow us to produce the most lightweight footwear in the safety sector.

- ESD approved shoes**
in accordance with EN 61340
- 100% metal-free shoe**
- Safety shoes S1P**
in accordance with EN ISO 20345
- Very lightweight shoe**
- Safety shoes S1PS according to EN ISO 20345:2022**
- Overcap**
Toe wear protection
- Safety shoes S3**
in accordance with EN ISO 20345
- Washable shoe**
- Safety shoes S3S according to EN ISO 20345:2022**
- Vegan shoe**
- Aluminum toe cap**
- Exchangeable insole**
- Metal-free toe cap**
- DGVU standard 112-191**
Suitable for orthopedic insoles in accordance with DGVU standard 112-191
- Slip resistance SR according to EN 13287**
- BOA® closure system**
for an easy fitting of the shoe
- Slip resistance SRC**
in accordance with EN 13287
- Reflektierende Einsätze**
- Penetration protection steel**
- Do not tumble dry**
- Penetration protection metal-free**
- ThinCap - toe cap**
light, thinner, athermic, non-metallic and non-magnetic

Safety shoes

Safety shoes Fresh / Color / Smart / Energy / Strong / Gravity Dynamic Line



Safety shoes; multiple upper options; composite toe cap; metal-free penetration protection; breathable lining; PU outsole; oil-resistant; slip-resistant; antistatic. EN ISO 20345:2011



dpvlink 28308



Article	Color	Upper	Size	Category	Form
FT-1082	grey / blue	suede	35-47	S1PS	low shoe
FT-1085	grey / blue	suede	38-47	S1PS	low shoe
FT-1084	black / rose	microfiber / HIGH TEX	34-42	S3S	low shoe
FT-1080	blue / black	STRETCH TEX	38-47	S3S	low shoe
FT-1081	black / blue	HIGH TEX	38-47	S3S	low shoe
FT-1083	black / blue	HIGH TEX	35-47	S1PS	sandal

Safety shoe Padel Sport Line



Safety shoe; upper STRETCH-TEX with leg edge padding; extra-thin plastic toe cap; metal-free penetration protection; anatomical, antibacterial insole; PU outsole; resistant to oil, acids and petrol; slip-resistant; antistatic. EN ISO 20345 S3S SR



dpvlink 28183



Article	Color	Size	Category
Safety shoe Padel Sport Line			
FT-1064	black / blue	38-47	S3S

Safety shoe Relay Sport Line



Safety shoe; upper mesh with leg edge padding and HIGH-TEX elements; extra-thin plastic toe cap; metal-free penetration protection; anatomical, antibacterial insole; PU outsole; resistant to oil, acids and petrol; slip-resistant; antistatic. EN ISO 20345 S1PS SR



dpvlink 28185

Article	Color	Size	Category
Safety shoe Relay Sport Line			
FT-1065	black / yellow	38-47	S1PS



Safety shoe Earth Gemini Line



Safety shoe; PU-Thread upper with padded leg edge, High-Tex inserts; metal-free penetration protection; composite toe cap; PU outsole; oil, acid and petrol resistant; slip-resistant; antistatic. EN ISO 20345



dpvlink 28406

Article	Color	Size	Category
Safety shoe Earth Gemini Line			
FT-1077	black	35-47	S3S



Safety sandal Charon Gemini Line



Safety sandal; upper safety nubuck with padded leg edge; metal-free penetration protection and toe cap; PU/TPU outsole; suitable for orthopedic insoles; oil-, acid- and benzene-resistant; slip-resistant; antistatic. EN ISO 20345:2011 S1P SRC



dpvlink 25915

Article	Color	Size	Category	Form
Safety sandal Charon Gemini Line				
FT-1072	black / orange	34-48	S1P	sandal



Safety shoes Saturn / Moon Gemini Line



Safety shoes; upper microfiber with padded leg edge; metal-free penetration protection and toe cap; antistatic Relax insole; PU/TPU outsole; suitable for orthopedic insoles (DGUV); oil-, acid- and benzene-resistant; slip-resistant; antistatic. EN ISO 20345:2011 S1P SRC



dpvlink 25912

Article	Color	Size	Category	Form
Safety shoes Saturn / Moon Gemini Line				
FT-1071	black / orange	38-48	S1P	low shoe
FT-1076	black / orange	38-48	S1P	boot



Safety shoes Mercury / Uranus Gemini Line



Safety shoes; upper safety nubuck with padded leg edge; metal-free penetration protection and toe cap; PU/TPU outsole; suitable for orthopedic insoles; oil-, acid- and benzene-resistant; slip-resistant; antistatic. EN ISO 20345:2011 S3 SRC



dpvlink 25909

Article	Color	Size	Category	Form
Safety shoes Mercury / Uranus Gemini Line				
FT-1070	black / orange	34-50	S3	low shoe
FT-1075	black / orange	34-50	S3	boot



Safety shoe Judo / Kayak Sport Line



Safety shoe; upper microfiber or microfiber with mesh; very thin plastic toe cap; metal-free penetration protection; anatomic, antibacterial insole; PU outsole; suitable for orthopedic insoles; oil-, acid- and fuel-resistant; slip-resistant; antistatic. EN ISO 20345:2011



dpvlink 23424

Article	Color	Size	Category	Upper	Form
Safety shoe Judo / Kayak Sport Line					
FT-1010	anthracite / black	35-47	S1P	microfiber / mesh	low shoe
FT-1018	anthracite / light grey	35-47	S3	microfiber	low shoe



Safety shoe Cycling Sport Line



Safety shoe; upper stretch tex with padded leg edge; metal-free penetration protection and toe cap; anatomic, antibacterial insole; 2-density PU outsole; suitable for orthopedic insoles (DGUV); oil-, acid- and benzine-resistant; slip-resistant; antistatic. EN ISO 20345:2011 S3 SRC



dpvlink 25838

Article	Color	Size	Category	Form
Safety shoe Cycling Sport Line				
FT-1040	black / red	38-47	S3	low shoe

Safety shoe Frisbee / Surf Sport Line



Safety shoe; upper mesh with padded leg edge; very thin plastic toe cap; metal-free penetration protection; anatomic, antibacterial insole; PU outsole; suitable for orthopedic insoles; oil-, acid- and fuel-resistant; slip-resistant; antistatic. EN ISO 20345:2011 S1P SRC



dpvlink 23350

Article	Color	Size	Category	Upper	Closure
Safety shoe Frisbee / Surf Sport Line					
FT-1024	black	35-47	S1P	mesh	lace fastening
FT-1025	black	35-47	S1P	mesh	velcro fastener

Safety shoe Douglas / Gladiator Professional Line



Safety shoe; upper nubuck with padded leg edge; composite toe cap; metal-free penetration protection; antibacterial insole; PU/PU outsole with overcap; suitable for orthopedic insoles; oil-, acid- and fuel-resistant; slip-resistant; antistatic. EN ISO 20345:2011 S3 SRC



dpvlink 23420

Article	Color	Size	Category	Upper	Form
Safety shoe Douglas / Gladiator Professional Line					
FT-8220	black / red	36-48	S3	nubuck	low shoe
FT-8221	black / red	36-48	S3	nubuck	boot

Safety shoe Junkers / Firebrand Professional Line



Safety shoe; upper microfiber with padded leg edge, composite toe cap; metal-free penetration protection; antibacterial insole; microfiber /PU outsole with overcap; suitable for orthopedic insoles; oil-, acid- and fuel-resistant; slip-resistant; antistatic. EN ISO 20345:2011 S3



dpvlink 23425

Article	Color	Size	Category	Upper	Form
Safety shoe Junkers / Firebrand Professional Line					
FT-8210	black / blue	38-48	S3	microfiber	low shoe
FT-8211	black / blue	38-48	S3	microfiber	boot

Insoles

Insoles FTG



- removable, preformed ESD insoles
- washable up to 30°C
- antibacterial
- high comfort and energy consumption

dpvlink 23347

Article	Type	Size
Insoles FTG		
FT-0976	ESD insole Soletta Sport for Sport Lite and Ducati Racing Line	36-48
FT-0975	ESD insole Relax for models Moon and Saturn	35-48
FT-0977	ESD insole Atomic for Professional Line	36-48



BATA INDUSTRIALS





















THE SAFETY SHOE

The safety shoes of Bata Industrials are characterized by excellent fitting, innovative design and best safety properties. Developing innovative solutions with new features and materials plays an important role for Bata Industrials.

With its different collections Bata also shows that safety shoes do not have to be boring. With its Radiance series Bata combines a sportive look, many functional properties and maximal protection. An example for this is the 3B Motion technology that gives the wearer an enormous increase in performance and ensure excellent wearing comfort.

In compliance with the ESD standard DIN EN 61340-5-1 



-  **ESD approved shoes**
in accordance with EN 61340
-  **Safety shoes S1**
in accordance with EN ISO 20345
-  **Safety shoes S1P**
in accordance with EN ISO 20345
-  **Safety shoes S1PS according to EN ISO 20345:2022**
-  **Safety shoes S3**
in accordance with EN ISO 20345
-  **Steel toe cap**
-  **Aluminum toe cap**
-  **Metal-free toe cap**
-  **Slip resistance SRC**
in accordance with EN 13287
-  **Penetration protection metal-free**
-  **100% metal-free shoe**
-  **Very lightweight shoe**
-  **Overcap**
Toe wear protection
-  **Vegan shoe**
-  **Exchangeable insole**
-  **DGVU standard 112-191**
Suitable for orthopedic insoles in accordance with DGVU standard 112-191
-  **BOA® closure system**
for an easy fitting of the shoe
-  **Shoe with Cool Comfort® textile lining**
-  **Shoe with a modular, ergonomic concept -**
Walkline® EVO technology inside
-  **Odor-inhibiting**
(Odor Control)

Safety shoes

Safety shoe Cernan



Safety shoe; textile upper (knitted leg); TPU overcap; plastic toe cap; FlexGuard® plastic penetration protection; mesh lining; antistatic; PU/PU outsole. EN ISO 20345 S1P SRC



dpvlink 28157

Article	Color	Size	Category
Safety shoe Cernan			
BT-61642	black	35-49	S1P



Safety shoe Energy



Safety shoe; upper mesh; TPU overcap; plastic toe cap; FlexGuard® plastic penetration protection; EVA midsole; antistatic; EVA/rubber outsole; EN ISO 20345 S3 SRC



dpvlink 28159

Article	Color	Size	Category	Sex
Safety shoe Energy				
BT-26417	grey / blue	35-47	S3	unisex



Safety shoe Rosa / Jane



Safety shoe and boot; suede upper; aluminum toe cap; polyester lining; EVA midsole; EVA/rubber outsole; FlexGuard® plastic penetration protection; antistatic, slip-resistant, EN ISO 20345



dpvlink 28191

Article	Color	Size	Category
Safety shoe Rosa / Jane			
BT-66106	black	34-42	S1PS
BT-65125	black	34-42	S3S



Safety sandal OPEN / FLOW



Safety sandal; upper textile; plastic toe cap; mesh lining; EVA midsole; rubber outsole; FlexGuard® plastic penetration protection; antistatic; slip-resistant; EN ISO 20345 S1P SRC



dpvlink 27306



Article	Color	Size	Category
Safety sandal OPEN / FLOW			
BT-26155	grey	35-47	S1P
BT-56156	black / red	35-47	S1P

Safety sandal Falcon ESD



Modern safety sandal with velcro fastener; upper suede; steel toe cap; lining mesh fabric; antistatic; PU/PU outsole; EN ISO 20345 S1 SRC



dpvlink 24116



Article	Color	Size	Category
Safety sandal Falcon ESD			
BT-60449	black / blue	35-49	S1

Safety shoe GOAL Black



Safety shoe; upper microfiber and leather; plastic toe cap; TPU overcap; PU midsole; PU outsole; textile lining; FlexGuard® plastic penetration protection; antistatic; EN ISO 20345 S3 SRC



dpvlink 27302



Article	Color	Size	Category
Safety shoe GOAL Black			
BT-GOAL-B-ESD	black / white	36-49	S3

Safety shoes Anna Lee / Bibian



Safety shoe; upper knitted fabric, microfiber and TPU film; aluminium toe cap; breathable lining; insoles of recycled PU foam; EVA outsole; antistatic; slip-resistant; EN ISO 20345 SRC HRO



dpvlink 26083



Article	Color	Size	Category
Safety shoes Anna Lee / Bibian			
BT-75072	green / grey	35-42	S1 women
BT-76075	green / grey	34-42	S1P women

Safety shoe Marie



Safety shoe; abrasion-resistant, woven textile upper; aluminium toe cap; EVA midsole; mesh lining; FlexGuard® plastic penetration protection; antistatic, EN ISO 20345 HRO S3 SRC



dpvlink 26086



Article	Color	Size	Category
Safety shoe Marie			
BT-76074	green	34-42	S3 women

Safety shoe Florence



Safety shoe; upper full-grain leather; aluminium toe cap; EVA midsole; mesh lining; FlexGuard® plastic penetration protection; antistatic, EN ISO 20345 HRO S1P SRC



dpvlink 26088

Article	Color	Size	Category
Safety shoe Florence			
BT-16071	green / grey	34-42	S1P



Safety boot Ada



Safety boot; upper full-grain leather; aluminium toe cap; TPU overcap; EVA midsole; mesh and polyester lining; FlexGuard® plastic penetration protection; antistatic, EN ISO 20345 S3 SRC



dpvlink 27353

Article	Color	Size	Category
Safety boot Ada			
BT-26073	green / grey	35-42	S3



Safety shoe FIT / VIM / SPARK ESD Radiance



Safety shoe; upper textile with TPU overcap; **Radiance series**; plastic toe cap and penetration protection; metal-free; breathable lining; Premium Fit insole; Vibram® outsole of EVA and rubber; antistatic, slip-resistant



dpvlink 23812

Article	Color	Size	Category
Safety shoe FIT / VIM / SPARK ESD Radiance			
BT-66419	grey / black	35-47	S1P
BT-66420	black / blue	35-47	S1P
BT-66426	black / red	35-47	S1P



Safety shoe VIGOR / VIBE ESD Radiance



Safety shoe; upper nylon; aluminum toe cap; FlexGuard® plastic penetration protection; mesh lining with Odor Control; antistatic; PU/TPU outsole



dpvlink 24949

Article	Color	Size	Category	Closure
Safety shoe VIGOR / VIBE ESD Radiance				
BT-66633	black / yellow	35-47	S1P	Boa® / quick-release fastener
BT-36634	black / red	35-47	S3	Boa® / quick-release fastener



Safety shoe SUMM TWO / ONE ESD



Safety shoe; upper nylon; aluminum toe cap; FlexGuard® plastic penetration protection; mesh lining with Odor Control; antistatic; PU/TPU outsole; EN ISO 20345 S3 SRC



dpvlink 24781

Article	Color	Size	Category	Form
Safety shoe SUMM TWO / ONE ESD				
BT-63592	black / blue	38-48	S3	low shoe
BT-63591	black / blue	38-48	S3	boot



Safety shoe SUMM FOUR ESD



Safety shoe; upper mesh (breathable); aluminum toe cap; FlexGuard® plastic penetration protection; mesh lining with Odor Control; antistatic; PU/TPU outsole; EN ISO 20345 S1P SRC



dpvlink 25246

Article	Color	Size	Category	Closure
Safety shoe SUMM FOUR ESD				
BT-63594	black / lime	38-48	S1P	Boa®



Safety shoe LEGEND / TURN ESD FWD



Safety shoe; upper mesh/TPU overcap; thermoplastic toe cap; FlexGuard® plastic penetration protection; Bata Cool Comfort® lining; antistatic; PU/PU outsole; EN ISO 20345 S1P SRC



dpvlink 21325

Article	Color	Size	Category	Closure
Safety shoe LEGEND / TURN ESD FWD				
BT-LEGEND-ESD	grey	38-48	S1P	Boa®

Safety shoe GOAL / SCORE ESD FWD



Safety shoe; upper microfiber/TPU overcap; thermoplastic toe cap; FlexGuard® plastic penetration protection; Bata Cool Comfort® lining; antistatic; PU/PU outsole; EN ISO 20345 S3 SRC



dpvlink 21319

Article	Color	Size	Category	Form
Safety shoe GOAL / SCORE ESD FWD				
BT-GOAL-ESD	black	38-48	S3	low shoe
BT-SCORE-ESD	black	38-48	S3	boot

Insoles

Insole Premium Fit



- POLIYOU® insole with mesh top layer: breathable and antibacterial
- good shock absorption due to cushioning of heel and ball
- light foot arch support offering stability
- ESD-compliant

dpvlink 26061

Article	Type	Size
Insole Premium Fit		
BT-90003	Insole Premium Fit	35-49



Fußgerechte Sicherheit

BAAK - ESD safety shoes with sporty and modern design and high-quality processing. Newest sole technology with excellent and all-over shock absorption. Comfortable to wear due to shock-absorbing and antibacterial insoles with particularly good moisture absorption and release. Comfort due to easy-care materials and non-marking outsoles.



Das BAAK® go&relax System

The revolution of the safety shoe

Our innovative system has especially been developed for people wearing safety shoes for many hours a day. For this customer group a natural and functional foot load distribution is particularly important - low-fatigue walking over the whole working day.



Einfach besser laufen.

- ESD approved shoes** in accordance with EN 61340
- Work shoes O1** in accordance with EN ISO 20347
- Safety shoes S1** in accordance with EN ISO 20345
- Safety shoes S1P** in accordance with EN ISO 20345
- Safety shoes S1PS according to EN ISO 20345:2022**
- Safety shoes S3** in accordance with EN ISO 20345
- Steel toe cap**
- Aluminum toe cap**
- Metal-free toe cap**
- Slip resistance SR according to EN 13287**
- Slip resistance SRC** in accordance with EN 13287
- Penetration protection metal-free**
- 100% metal-free shoe**
- Very lightweight shoe**
- Overcap** Toe wear protection
- Vegan shoe**
- Exchangeable insole**
- DGVU standard 112-191** Suitable for orthopedic insoles in accordance with DGVU standard 112-191
- BOA® closure system** for an easy fitting of the shoe
- Baak® go & relax system** Flex cap and flex zone for a healthy bending of the foot
- Knee- and back-friendly:** Scientifically tested

Safety shoes

Safety shoes Randy / Ray / Rob3



Safety shoe and sandal; perforated nubuck upper; composite toe cap; textile penetration protection; suitable for orthopedic insoles; rubber sole with flex zone; slip-resistant. EN ISO 20345:2011



dpvlink 28238

Article	Color	Size	Category
Safety shoes Randy / Ray / Rob3			
BA-210011	black / grey	36-48	S1P
BA-210022	black / grey	36-48	S1P
BA-210012	black / grey	36-48	S3

Safety shoes Adam / Admiral John / Alex



Safety shoe and sandal; microfiber upper and TPU reinforcement; breathable sandwich textile made from 65% recycled material; composite toe cap; textile penetration protection; suitable for orthopedic insoles; rubber sole with flex zone; slip-resistant. EN ISO 20345:2011



dpvlink 28242

Article	Color	Size	Category
Safety shoes Adam / Admiral John / Alex			
BA-223011	black / yellow	38-48	S1PS
BA-223022	black / yellow	38-48	S1PS
BA-223012	black / yellow	38-48	S3S

Safety shoe Hallux



Safety shoe; textile upper; steel toe cap; EVA midsole; textile penetration protection; suitable for orthopedic insoles; rubber sole with flex zone; slip-resistant. EN ISO 20345:2011



dpvlink 28246

Article	Color	Size	Category
Safety shoe Hallux			
BA-214072	grey / lime	35-42	S1PS

Safety sandal Sun



Safety sandal with two velcro fasteners; upper breathable nylon; composite toe cap; metal-free penetration protection; EVA/nitrile outsole, slip-resistant (non-marking). EN ISO 20345:2011 S1P SRC



dpvlink 27439

Article	Color	Size	Category
Safety sandal Sun			
BA-5521	black	35-48	S1P

Safety shoe Conner



Safety shoe made of breathable textile material; nano fiberglass flexible cap; suitable for orthopedic insoles; LIEVA (liquid injected EVA) / nitrile outsole; ultra-light; all-over cushioning; very breathable; metal- and leather-free, slip-resistant. EN ISO 20345:2011 S1 SRC



dpvlink 20996

Article	Color	Size	Category
Safety shoe Conner			
BA-5001	grey / black	39-48	S1

Safety shoe Herby / Harry



Safety shoe of microfiber with mesh textile insert; aluminum toe cap; suitable for orthopedic insoles; PU/PU outsole; very breathable; non-marking, slip-resistant. EN ISO 20345:2011 S1 SRC



dpvlink 21005

Article	Color	Size	Category	Closure
Safety shoe Herby / Harry				
BA-7008	black / blue	36-47	S1	quick-release fastener
BA-7228	black / blue	36-47	S1	velcro fastener

Safety sandal Henry



Safety sandal with two velcro fasteners; upper cowhide suede with reflective appliqué; steel toe cap; metal-free penetration protection; suitable for the supply with insoles; PU/PU outsole, slip-resistant (non-marking). EN ISO 20345:2011 S1P SRC



dpvlink 21170

Article	Color	Size	Category
Safety sandal Henry			
BA-8424	black / grey	37-48	S1P

Safety shoe Hardy/Henk



Safety shoe made of abrasion-resistant microfiber with textile elements; perforated; soft padded shaft edge; aluminium toe cap; flexible insole with penetration protection; suitable for orthopedic insoles; PU outsole with PU midsole; antibacterial, fungicidal, robust; slip-resistant. EN ISO 20345 S1P SRC
 Sizes 36-47 in width 11; size 48 in width 13



dpvlink 19547

Article	Color	Size	Category	Closure
Safety shoe Hardy/Henk				
BA-7227	black / grey	36-48	S1P	velcro fastener
BA-7007	black / grey	36-48	S1P	quick-release fastener

- Special sizes 49 + 50 and other width on request -

Safety shoe Hugo



Safety shoe; upper suede with reflective appliqué; steel toe cap; metal-free penetration protection; suitable for the supply with insoles; PU/PU outsole, slip-resistant (non-marking). EN ISO 20345:2011 S1P SRC



dpvlink 21172

Article	Color	Size	Category
Safety shoe Hugo			
BA-8724	black / grey	35-48	S1P

Safety shoe Hector 2



Safety shoe with reflective PI appliqué; upper microfiber with mesh textile insert; aluminum toe cap; suitable for orthopedic insoles; PU/PU outsole; weight 410g/piece (size 42); very breathable; slip-resistant. EN ISO 20345:2011 S1 SRC



dpvlink 21008

Article	Color	Size	Category
Safety shoe Hector 2			
BA-54012	black / grey	38-48	S1P

Safety shoe Svea



Sporty safety shoe; upper nylon material with decorative TPU appliqué (abrasion-resistant and water-repellent); steel toe cap; metal-free penetration protection; suitable for orthopedic insoles, EVA/nitrile outsole, slip-resistant (non-marking). EN ISO 20345:2011 S3 SRC



dpvlink 23548

Article	Color	Size	Category
Safety shoe Svea			
BA-3218	black / turquoise	34-42	S3

Safety shoe Sonja



Modern safety shoe; with nylon inserts; upper microfiber in leather optics; steel toe cap; textile penetration protection; suitable for orthopedic insoles; EVA/nitrile outsole, slip-resistant. EN ISO 20345



dpvlink 24219

Article	Color	Size	Category	Standard width
Safety shoe Sonja				
BA-3219	grey	35-42	S1P	10 women



Safety shoe Red / Reeny



Safety shoe made of abrasion-resistant microfiber with textile elements; perforated; soft padded shaft edge; metal- and leather-free; composite toe cap; flexible insole with penetration protection; suitable for orthopedic insoles; all-over cushioning due to EVA midsole; nitrile outsole; antibacterial; fungicidal; robust; slip-resistant; non-marking. EN ISO 20345 S1P SRC



dpvlink 19541

Article	Color	Size	Category
Safety shoe Red / Reeny			
BA-71502	black / red	36-48	S1P
BA-71522	black / green	36-48	S1P



Safety shoe Stan / boot Stanley



Safety shoe of breathable, water-resistant nylon with TPI appliqué; composite toe cap; suitable for orthopedic insoles; EVA/nitrile outsole; full-surface shock absorption; very breathable; metal-free, slip-resistant. EN ISO 20345:2011 S3 SRC



dpvlink 24216

Article	Color	Size	Category	Form
Safety shoe Stan / boot Stanley				
BA-5518	black	35-48	S3	low shoe
BA-5618	black	35-48	S3	boot



Safety shoe Robert2



Safety boot, upper robust nubuck; water-repellent; climate-regulating lining; metal- and leather-free; composite toe cap; flexible insole; suitable for orthopedic insoles; all-over cushioning due to EVA midsole; nitrile outsole; robust; slip-resistant; non-marking. EN ISO 20345



dpvlink 19537

Article	Color	Size	Category	Form
Safety shoe Robert2				
BA-73742	black / grey	36-48	S3	boot



Safety shoe Sam



Modern safety shoe; upper water-resistant nylon; composite toe cap; metal-free penetration protection; suitable for orthopedic insoles; EVA/nitrile outsole, slip-resistant (non-marking). EN ISO 20345:2011 S3 SRC



dpvlink 24770

Article	Color	Size	Category
Safety shoe Sam			
BA-5520	black	35-48	S3



Safety shoe Rick2



Safety shoe; upper microfiber with textile elements; metal- and leather-free; composite toe cap; suitable for orthopedic insoles; all-over cushioning due to EVA midsole; nitrile outsole; robust; slip-resistant. EN ISO 20345



dpvlink 19532

Article	Color	Size	Category
BA-71462	Safety shoe Rick2 blue / yellow	36-48	S1P



Safety sandal Rene2



Safety sandal made of microfiber with textile elements; padded shaft edge; velcro fastener; metal- and leather-free; composite toe cap; flexible insole; suitable for orthopedic insoles; antibacterial; fungicide; EVA midsole; nitrile outsole; robust; slip-resistant. EN ISO 20345 S1P SRC



dpvlink 19531

Article	Color	Size	Category
BA-72112	Safety sandal Rene2 blue / yellow	36-48	S1P



Safety shoe Rui



Modern safety shoe; upper water-resistant microfiber with TPU appliques; wide composite toe cap; resized width; textile penetration protection; suitable for orthopedic insoles; EVA/nitrile outsole, slip-resistant (non-marking). EN ISO 20345:2011 S3 SRC



dpvlink 24224

Article	Color	Size	Category
BA-73181	Safety shoe Rui black	36-48	S3



Safety shoe Paul



Safety shoe made of calf suede with reflective applications; steel toe cap; textile penetration protection; suitable for orthopedic insoles; PU midsole; PU outsole with flexline for easy rolling movement; abrasion-resistant, robust, slip-resistant (non-marking). EN ISO 20345:2011 S1P SRC



dpvlink 18286

Article	Color	Size	Category
BA-7003	Safety shoe Paul blue / grey	38-48	S1P



- Special sizes 49 + 50 on request -

Safety shoe Peter / boot Philipp



Safety shoe made of hydrophobic calf nubuck with reflecting appliques; steel toe cap; textile penetration protection; exchangeable insole; suitable for orthopedic insoles; PU midsole; PU outsole with flexline for an easy roll; abrasion-resistant, robust, slip-resistant (non-marking). EN ISO 20345:2011 S3 SRC



dpvlink 18288

Article	Color	Size	Category	Form
BA-7204	Safety shoe Peter / boot Philipp black / grey	38-48	S3	low shoe
BA-7304	black / grey	38-48	S3	boot



Safety shoe Homer / Hudson



Safety shoe; made of elastic and breathable flex mesh material with closed sock construction; Baak® go&relax system; flex zone in the ball area and H-coupling element for foot-friendly bending; lightweight aluminum flex cap; suitable for orthopedic insoles; slip-resistant.



dpvlink 26259

Article	Color	Size	Category
BA-5203	Safety shoe Homer / Hudson black / blue	38-48	S1P
BA-5204	black / blue	38-48	S1P



Safety shoe Sky / Occupational shoe Cloud



Upper textile, knitted leg with partially elastic hallux area and padded leg end: textile functional lining; Baak® go&relax system; flex zone in the ball area and H-coupling element for foot-friendly bending; suitable for orthopedic insoles; slip-resistant. EN ISO 20345



dpvlink 26818

Article	Color	Size	Category
Safety shoe Sky / Occupational shoe Cloud			
BA-125002	blue	35-48	01
BA-215072	blue	35-48	S1P



Insoles

ESD Softstep+ insole



suitable for BAAK ESD shoes

- softly shock-absorbing insole
- correct fitting with heel cup and soft support in the metatarsus region
- breathable, conductive, antibacterial

dpvlink 25697

Article	Type	Size
ESD Softstep+ insole		
BA-4664	ESD Softstep+ insole women 4664	34-42
BA-4665	ESD Softstep+ insole N 4665	35-50
BA-4666	ESD Softstep+ insole XW 4666	39-50



Orthopedic insoles



Since 2007 the **DGVU standard 112-191 (formerly BGR 191)** has clearly regulated the use of orthopedic insoles in safety shoe and the individual finishing of safety shoes. According to the standard, only modifications of the safety shoe approved by a certified testing authority and attested by an EC type examination certificate are permitted.

Especially in case of shoes having to fulfill the ESD standard EN 61340-5-1, the use of certified orthopedic insoles is essential as those ensure the necessary contact and assure all in all the required ESD protection.

- Safety shoes serve the safety at work
- In these shoes only orthopedic insoles certified for the respective shoe may be used
- The certified insoles in ESD shoes ensure at the same time that the ESD function is maintained

Orthopedic insoles - it's as easy as that:



1. Check if the shoe you use is certified.
2. Request the molded foam for your footprint.
3. After receiving the molded foam create the imprint of your foot by setting your foot carefully in the molded foam.

4. Do you have a private prescription? Put it in a closed envelop and add it to the molded foam with your footprint. So, the insole can be adapted more individually and more precisely to your foot.
5. Return the molded foam with your footprint to us or give it to an orthopedic shoe technician.

When returning the molded foam, the following informations are necessary for fabricating the insoles:
shoe model with size and name of the insole wearer

6. After shoe finishing you will receive your insole either from Orthopädie-Schuhtechnik Granget or us. So, you still wear a certified work shoe.



All shoes with this icon have been certified by the respective manufacturer according to the DGVU standard 121-191.

dpvlink 26072

Article	Type
DPV-3550.Einlagen	Customized insole ESD
DPV-3550.Schaum	Foam for footprint



ESD Socks

ESD socks Basic



86% cotton, 12% polyester, 1% elastane, 1% Bekinox®

- anatomically shaped footbed
- skin-friendly materials
- highly elastic, non-constricting cuffs
- washable up to 30°C
- available sizes 36-38, 39-41, 42-43, 44-45, 46-47

dpvlink 22632

Article	Size
ESD socks Basic	
EL-900019	35-50

ESD socks 8201 LIGHT



50% modal, 36% nylon, 12% polyester, 1% elasthan, 1% carbon fiber

- very good fit, fine
- breathable and odor-inhibiting
- protection against wet feet and abrasions
- washable up to 40°C
- available sizes 36-38, 39-41, 42-43, 44-45, 46-47

dpvlink 19672

Article	Size
ESD socks 8201 LIGHT	
JA-8201	36-47

ESD Line socks



90% polyester, 7% elastane, 3% silver treads

- Perfectly fitting and flexible socks
- conductive fibers in the heel and toe
- washable up to 40°C
- with ESD logo

dpvlink 14258

Article	Color	Size
ESD Line socks		
2720.4260.S	white / grey	36-38
2720.4260.M	white / grey	39-40
2720.4260.L	white / grey	41-42
2720.4260.XL	white / grey	43-45
2720.4260.XXL	white / grey	46-48

All Season COTTON ESD socks



49% cotton, 22% polyamide, 17% polyester, 9% acryl, 2% elastane, 1% Bekinox® (metal fibers)

- adapts to the temperature of the foot
- absorbs up to 80% moisture
- strong
- washable up to 40°C
- available sizes 35-38, 39-42, 43-46, 47-50

dpvlink 19623

Article	Color	Size
All Season COTTON ESD socks		
BT-11300	grey	35-50

All Season Merino WOOL ESD socks



45% wool, 26% polyamide, 17% Pro-Cool polyester, 9% Amicor TM Pure, 2% Lycra (elastane), 1% Bekinox® (metal fibers)

- adapts to the temperature of the foot
- absorbs up to 30% humidity
- elastic and dirt-resistant
- washable up to 40°C
- available sizes 35-38, 39-42, 43-46, 47-50

dpvlink 19622

Article	Size
All Season Merino WOOL ESD socks	
BT-11404	35-50

ESD socks COOL



All models of this collection contain Pro-Cool® oder Polyfresh®. The fiber transports the sweat from the foot to the shoe lining through the sock. This keeps the feet dry and cool preventing blister.

Sizes 35-38, 39-42, 43-46, 47-50



dpvlink 17395

Article	Color	Size
ESD socks COOL		
BT-10102	black / blue	35-50
BT-10101	black	35-50
BT-10100	black / grey	35-50

ESD socks



66% cotton, 31% polyamide, 2% elasthan, 1% carbon fiber

- comfortable ESD socks
- nearly seamless, no rubbing against the skin
- durable, dimensionally stable
- toe and heel area slightly padded
- color: graphite/grey
- washable up to 40°C
- available in the sizes 36-39, 40-42, 43-46

dpvlink 24787

Article	Color	Size
ESD socks		
SI-99360	graphite / grey	36-46

ESD sneaker socks



40% polyamide, 42% Microlon polyamide, 14% polypropylen, 2% elasthan, 2% carbon fiber

- comfortable ESD sneaker socks
- angle-high, soft socks
- toe and heel area slightly padded
- durable
- color: graphite/grey
- washable up to 40°C

available in the sizes 36-39, 40-42, 43-46

dpvlink 24789

Article	Color	Size
ESD sneaker socks		
SI-99372	graphite / grey	36-46

ESD Lady Bamboo



A lightweight and very soft working sock tailored to the shape and size of a woman's foot. Due to the combination of moisture-regulating properties and Pro-Cool®, the feet are always dry and fresh. Sizes 35-38, 39-42

[dpvlink 27360](#)

Article



ESD Lady Bamboo

BT-13191

ESD Lady Cotton



The all-around working sock is tailored to the shape and size of a woman's foot. Due to the combination of Pro-Cool® and ventilation channels, the feet are always dry and fresh. The antibacterial silver does not give any chance for odors. Sizes 35-38, 39-42

[dpvlink 27362](#)

Article



ESD Lady Cotton

BT-13121

Shoe care products

Fresh shoe deo spray





Fresh shoe deo spray with long-term effect

- colorless
- long-lasting fragrance
- eco-friendly pump dispenser

[dpvlink 23170](#)



Article	Type
 2500.B1505	Shoe-Fresh Bama 100 ml spray bottle
 2500.B1508	Trainer Fresh Bama Antibacterial effect - eliminates 99.9% of bacteria 100 ml spray bottle

Express shine sponge Bama



BAMA express shine sponge for fast care of smooth leather shoes - shiny shoes without polishing

- specially for smooth leather
- protects and gives intensive shine
- colorless
- content: 5 ml

[dpvlink 23298](#)



Article	Type
2500.B1603	Express shine sponge Bama, 5 ml

Fine wax care Bama



BAMA Fine wax care for the intensive care of smooth leather shoes

- ideal for all types of smooth leather
- cares and protects sensitive and high-quality leather
- gives shine
- colorless
- content: 250 ml

[dpvlink 23300](#)



Article	Type
2500.B1608	Fine Wax care Bama, 250 ml

Cleansing and caring foam Bama



BAMA Cleansing and caring foam cleans and cares effectively all materials

- effective care and cleaning for all materials
- tested and recommended for breathable membranes
- removes also snow and salt stains
- colorless
- content: 300 ml

[dpvlink 23302](#)



Article	Type
2500.B1612	Cleansing and caring foam Bama, 300 ml

Active Universal care Bama



BAMA Active universal care cares, protects and refreshes the colors of the materials and can be used on shoes, jackets and bags

- suitable for all materials like e.g. smooth, suede and patent leather as well as synthetic materials, textile and material combinations
- tested and recommended for breathable membranes
- colorless
- content: 300 ml

dpvlink 23304

Article Type

2500.B1613 Active Universal care Bama, 300 ml



Impregnating spray Bama



BAMA Universal impregnating spray protects the material from moisture and dirt

- suitable for all materials like e.g. smooth, suede and patent leather as well as synthetic materials, textile and material combinations
- tested and recommended for breathable membranes
- colorless
- content: 400 ml

dpvlink 23306

Article Type

2500.B1620 Impregnating spray Bama, 400 ml



Protector 3x3 WOLY



Highly effective impregnation spray, suitable for all textiles, smooth and rough leather

- colorless
- repels oil and dirt
- recommended for shoes and textiles with climatic membrane

dpvlink 18059

Article Type

2500.W1530 Protector WOLY, 250 ml



High-Tech-Lotion WOLY



Profitable care emulsion, especially made for high-tech materials like smooth leather, reptile and patent leather.

- color-untensifying, provides gloss and a comfortable grip
- fruity fresh fragrance
- suitable for all colors
- protects the material against environmental influences

dpvlink 20342

Article Type

2500.W1489.N High-Tech-Lotion WOLY, 75 ml



Heel grounders and overshoes

Mobile dispenser for overshoes CANMAT S-50 and S-100



The mobile dispensers for overshoes CANMAT S-50 and S-100 were developed especially for visitors of ESD protected zones and cleanroom areas. There is no more troublesome bending down - long waiting periods of visitor groups can thus be avoided. Both CANMAT dispensers can be placed quickly and easily, everywhere.



CANMAT S-100



CANMAT S-50

- Ideal for large groups
- Easy filling
- Visible filling level
- High capacity
- Quick and easy handling
- mechanical operation (without electricity)

Handling:

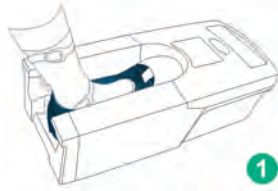

1 Put your foot on the metal plate of the CANMAT S-50 / S-100.

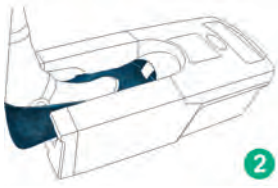

2 Draw your foot back while an overshoe is being fitted on over your shoe.

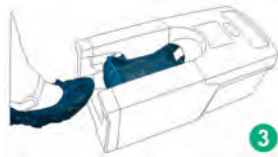

3 Draw your foot back until the clips have released and the overshoe has been completely put over your shoe. Then put the black grounding strap of the overshoe into your shoe - ready!

Overshoes for CANMAT **S-50** and **S-100** - see article number 2560.860.S110

PU/Magazine = 80 pieces, only complete PUs available

In compliance with ESD standard DIN EN 61340-5-1 

dpvlink 14716		QR
Article	Type	
2560.860.S050	Mobile Dispenser CANMAT S-50 Capacity: 100 pieces Dimensions: 690 x 320 x 230mm (LxWxH) Weight: 8.6 kg	
2560.860.S100	Mobile Dispenser CANMAT S-100 Capacity: 200 pieces Dimensions: 740 x 310 x 900 mm (LxWxH) Weight: 18 kg	

Disposable overshoes ESD for CANMAT S-50 and S-100



Disposable overshoes ESD with contact strap

- for CANMAT S-50 or CANMAT S-100
- **slip- and water-resistant**
- white
- one size fits all 35-48
- PU magazine = 80 pieces



In compliance with the ESD standard DIN EN 61340-5-1 

dpvlink 23857		QR
Article	Type	
2560.860.S110	Disposable overshoes ESD for CANMAT S-50 and S-100	

Further overshoes, also as non-ESD version, available on request.

Disposable overshoes



- Disposable overshoe for outdoor shoes
- with contact strap
- Eco 300 PU = 120 pieces / bag (60 pairs)
- Premium 400 PU = 100 pieces / bag (50 pairs)

In compliance with ESD standard DIN EN 61340-5-1 



dpvlink 118

Article	Type	Size	Color	QR
2560.830.1.60	Eco 300	35-47	light blue	
2560.835.1.50	Premium 400	35-48	light blue	

Reusable overshoe type PCR-125

- Reusable overshoe for outdoor shoes
- outsole made of conductive rubber material
- **anti-slip profile**
- contact strap with conductive carbon coating (exchangeable)
- PU = 1 pair

In compliance with ESD standard DIN EN 61340-5-1 



dpvlink 21219

Article	Type	Size	Color	QR
2760.PCR125.1	Reusable overshoe type PCR-125 size 1	35-39	white	
2760.PCR125.2	Reusable overshoe type PCR-125 size 2	40-43	white	
2760.PCR125.3	Reusable overshoe type PCR-125 size 3	44-48	white	

Replaceable contact strap for reusable overshoes type PB 120 and type PCR-125

dpvlink 8290

Article	Type	QR
2760.PB120.40	Replaceable contact strap PU= 100 pieces	

Overshoes

- Cleanroom overshoe
- ankle-high
- elastic band
- upper integrity 1750 antibacterial
- synthetic leather outsole
- washable up to 60°C according to industrial washing process

In compliance with the ESD standard DIN EN 61340-5-1



dpvlink 10145

Article	Type	Size	Color
1000.3900.36-37	Overshoes size 1	36-37	white
1000.3900.38-39	Overshoes size 2	38-39	white
1000.3900.40-43	Overshoes size 3	40-43	white
1000.3900.44-46	Overshoes size 4	44-46	white
1000.3900.47-48	Overshoes size 5	47-48	white
1000.3910.36-37	Overshoes size 1	36-37	light blue
1000.3910.38-39	Overshoes size 2	38-39	light blue
1000.3910.40-43	Overshoes size 3	40-43	light blue
1000.3910.44-46	Overshoes size 4	44-46	light blue
1000.3910.47-48	Overshoes size 5	47-48	light blue

Reusable overshoe Type PB-120

- Reusable overshoe for outdoor shoes
- upper material of 98% polyester and 2% conductive yard
- outsole made of conductive rubber material
- contact strap with conductive carbon coating (exchangeable)
- PU = 5 pairs/bag

In compliance with ESD standard DIN EN 61340-5-1



dpvlink 8286

Article	Type	Size	Color
2760.PB120.1	Reusable overshoe type PB-120 size 1	35-39	white
2760.PB120.2	Reusable overshoe Type PB-120 size 2	40-43	white
2760.PB120.3	Reusable overshoe Type PB-120 size 3	44-48	white

Disposable heel grounder



Conductive polyester strap, self-adhesive, for visitors with normal outdoor shoes or boots, yellow/black.

In compliance with the ESD standard DIN EN 61340-5-1

dpvlink 121

Article	Type	L [mm]
2560.894	Pack with 100 heel grounders	300
2560.894.600	Pack with 100 heel grounders	600

Wall-mounted container for disposable heel grounders

Screw-on wall mount made of plastic for always handy disposable heel grounders



dpvlink 5862

Article	Type
2560.894.H	Wall-mounted container for disposable heel grounders 300 mm
2560.894.H-600	Wall-mounted container for disposable heel grounders 600 mm

Permanent heel grounder for visitors

Permanent heel grounder with clip closure for visitors with exchangeable contact strips, with snap fastener. 1 MOhm safety resistance. 



dpvlink 110

Article	Type
2560.893.R.blue	Permanent heel grounder with snaps for contact stripes, clip closure (incl. contact stripes)
2560.893.R.red	Permanent heel grounder with snaps for contact stripes, clip closure (incl. contact stripes)



Contact strips



- replacement contact strips ESD
- textile and carbon
- snap 10 mm

In compliance with the ESD standard DIN EN 61340-5-1 

dpvlink 5863

Article	Type
2560.893.R.050	Contact strips PU = 50 pieces Length 50 cm
2560.893.R.100	Contact strips PU = 25 pieces Length 100 cm



Permanent heel grounder with velcro fastener

Permanent heel strap for men and women with velcro fastener. Usable for outdoor shoes with flat heel. 1 MOhm safety resistance. 



dpvlink 104

Article	Closure	Color
2560.890	Permanent heel grounder with velcro fastener velcro fastener	red / blue



Permanent heel grounder D-ring

Permanent heel grounder, D-ring with velcro fastener and large contact surface in the heel area; 1 MOhm safety resistance. 



dpvlink 12945

Article	Closure	Color	Contact strip length
2560.890.HGS	Permanent heel grounder D-ring velcro fastener	red / black	400 mm



Permanent heel grounder with clip closure

Permanent heel strap for men and women with clip closure, usable for outdoor shoes with flat heel. 1 MOhm/1.5 MOhm safety resistance. 



dpvlink 13877

Article	Closure	Color	Contact strip length
Permanent heel grounder with clip closure			
2560.890.2	Clip closure	blue / black	400 mm
2560.890.2R	Clip closure	red / black	400 mm
2560.890.3G	Clip closure	neon yellow / black	450 mm
2560.890.3G-90	Clip closure	neon yellow / black	900 mm



Women's permanent toe grounder

Permanent toe grounder for outdoor shoes with high heel. 1 MOhm / 1.5 MOhm safety resistance. 



dpvlink 107

Article	Closure	Color	Contact strip length
Women's permanent toe grounder			
2560.891	Standard	black / grey	510 mm
2560.891.2R	velcro fastener	red	510 mm
2560.891.3G	Clip closure	black / yellow	600 mm



Permanent sole grounder women / men

Permanent sole grounder with velcro fastener and large contact surface in heel and ball area.

1 MOhm safety resistance. 



dpvlink 19027

Article	Type	Size	Contact strip length	L [mm]
Permanent sole grounder women / men				
2560.SG1.S	Small	34-37	168 mm	160
2560.SG1.M	Medium	38-41	185 mm	165
2560.SG1.L	Large	42-45	210 mm	170
2560.SG1.XL	Extra large	46-50	228 mm	175



Sole cleaning

Tacky mats

In controlled ESD areas and cleanrooms, the use of **tacky mats** or **adhesive mats** has proven its worth as an ideal tool for cleaning shoe soles and cart wheels. Whether they are used in the semiconductor, pharmaceutical or also in electronic industries, adhesive mats are an **useful barrier against dust**.



You have the choice between disposable peel-off mats or permanently tacky mats. Both types have such an **adhesive force** that only dust and other particles stick on the mat.

Tacky mats permanent



Permanently tacky mat; cleanable only with warm water, mat regains its adhesive properties after drying.

dpvlink 442

Article	W [mm]	L [mm]	Thickness [mm]
1000.105.3	1200	600	3
1000.106.3	1000	1000	3
1000.105.5	1200	600	6
1000.106.5	1000	1000	6



Foil tacky mats 30 layers

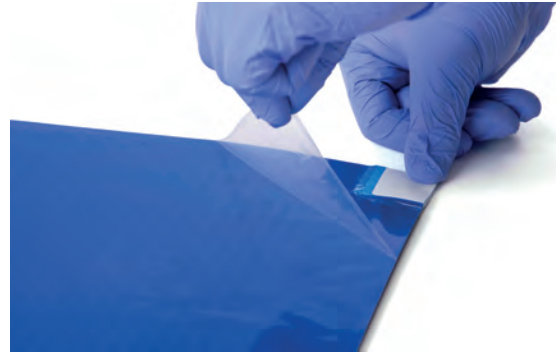

Foil tacky mats with high adhesive force, 30 layers with sequential numbering, in case of decreasing adhesive force, just remove the dirty foil, the new foil is immediately ready for use.

dpvlink 437

Article	W [mm]	L [mm]	Color
1000.030.1	1140	460	white / transparent
1000.030.3	1140	610	white / transparent
1000.030.1.blau	1140	460	blue
1000.030.3.blau	1140	610	blue



Accessories for foil tacky mats



Frame for mat size 1140 x 610 mm

- rubber frame to edge foil tacky mats
- sloping edges
- cut-out inner part
- easy insertion of the mats
- ideal for sliding
- height 2 to 5 mm
- edge width 70 mm
- color dark grey

dpvlink 23849

Article	Accessories for foil tacky mats
1000.030.3.R	Frame for foil stacky mat 1000.030.3



WhiteLine plus EPAwear®

Work coat WhiteLine plus WL-185



- very comfortable to wear
- hard-wearing and durable
- breathable and lightweight
- optimal ESD protection

The unisex work coat WhiteLine plus 185 is available in 3 designs:



3/4 design, long sleeves



1/2 design, long sleeves



1/2 design, short sleeves



All models with 2 side pockets, breast pocket with woven ESD symbol, white pocket piping, lapel collar and continuously covered snap fastener.

Mixed fabric, weight 150 g/m²
67% polyester, 31% cotton and 2% conductive yarn
Machine washable up to 60°C

Available sizes: XS, S, M, L, XL, XXL, 3XL, 4XL

In compliance with ESD standard DIN EN 61340-5-1 

dpvlink 23765

Article	Type	Sleeve length	Size
Work coat WhiteLine plus WL-185			
2710.WL185-P	3/4 design	long sleeves	XS-4XL
2711.WL185-P	1/2 design	long sleeves	XS-4XL
2712.WL185-P	1/2 design	short sleeves	XS-4XL



Work coat WhiteLine plus WL-180



- very comfortable to wear
- hard-wearing and durable
- breathable and lightweight
- optimal ESD protection

The unisex work coat WhiteLine plus 180 is available in 3 designs:



3/4 design, long sleeves



1/2 design, long sleeves



1/2 design, short sleeves



All models with 2 side pockets, breast pocket with woven ESD symbol, dark blue pocket piping, lapel collar and continuously covered snap fastener.

Mixed fabric, weight 150 g/m²
67% polyester, 31% cotton and 2% conductive yarn
Machine washable up to 60°C

Available sizes: XS, S, M, L, XL, XXL, 3XL, 4XL

In compliance with ESD standard DIN EN 61340-5-1 

dpvlink 23771

Article	Type	Sleeve length	Size
Work coat WhiteLine plus WL-180			
2710.WL180-P	3/4 design	long sleeves	XS-4XL
2711.WL180-P	1/2 design	long sleeves	XS-4XL
2712.WL180-P	1/2 design	short sleeves	XS-4XL



Work coat WhiteLine plus WL-181



- very comfortable to wear
- hard-wearing and durable
- breathable and lightweight
- optimal ESD protection

The unisex work coat WhiteLine plus 181 is available in 3 designs:



3/4 design, long sleeves



1/2 design, long sleeves



1/2 design, short sleeves



All models with 2 side pockets, breast pocket with woven ESD symbol, dark blue pocket piping, grey edging, lapel collar and continuously covered snap fastener.

Mixed fabric, weight 150 g/m²
67% polyester, 31% cotton and 2% conductive yarn
Machine washable up to 60°C

Available sizes: XS, S, M, L, XL, XXL, 3XL, 4XL

In compliance with ESD standard DIN EN 61340-5-1

dpvlink 23772

Article	Type	Sleeve length	Size
Work coat WhiteLine plus WL-181			
2710.WL181-P	3/4 design	long sleeves	XS-3XL
2711.WL181-P	1/2 design	long sleeves	XS-4XL
2712.WL181-P	1/2 design	short sleeves	XS-4XL



Work coat WhiteLine plus WL-182



- very comfortable to wear
- hard-wearing and durable
- breathable and lightweight
- optimal ESD protection

The unisex work coat WhiteLine plus 182 is available in 3 designs:



3/4 design, long sleeves



1/2 design, long sleeves



1/2 design, short sleeves



All models with 2 side pockets, breast pocket with woven ESD symbol, dark blue pocket piping, blue edging, lapel collar and continuously covered snap fastener.

Mixed fabric, weight 150 g/m²
67% polyester, 31% cotton and 2% conductive yarn
Machine washable up to 60°C

Available sizes: XS, S, M, L, XL, XXL, 3XL, 4XL

In compliance with ESD standard DIN EN 61340-5-1

dpvlink 23773

Article	Type	Sleeve length	Size
Work coat WhiteLine plus WL-182			
2710.WL182-P	3/4 design	long sleeves	XS-3XL
2711.WL182-P	1/2 design	long sleeves	XS-4XL
2712.WL182-P	1/2 design	short sleeves	XS-4XL



WhiteLine plus Woman

Work coat WhiteLine plus Woman WLW-175



The WhiteLine women's coat always makes you look good by its figure-hugging cut; for a perfect wearing comfort due to a high-quality finish and maximum mobility.

- very comfortable to wear
- hard-wearing and durable
- breathable and lightweight
- optimal ESD protection

The women's work coat WhiteLine plus Woman 175 is available in 3 designs:



3/4 design, long sleeves

1/2 design, long sleeves

1/2 design, short sleeves

All models with 2 side pockets, breast pocket with woven ESD symbol, white pocket piping, lapel collar and continuously covered snap fastener.



Mixed fabric, weight 150 g/m²
67% polyester, 31% cotton and 2% conductive yarn
Machine washable up to 60°C

Available sizes: XS, S, M, L, XL, XXL, 3XL

In compliance with ESD standard DIN EN 61340-5-1 

dpvlink 24196

Article	Type	Sleeve length	Size
Work coat WhiteLine plus Woman WLW-175			
2710.WLW175-P	3/4 design	long sleeves	XS-3XL
2711.WLW175-P	1/2 design	long sleeves	XS-3XL
2712.WLW175-P	1/2 design	short sleeves	XS-3XL



GreyLine plus

Work coat GreyLine plus GL-185



- very comfortable to wear
- hard-wearing and durable
- breathable and lightweight
- optimal ESD protection

The unisex work coat GreyLine plus 185 is available in 3 designs:



3/4 design, long sleeves

1/2 design, long sleeves

1/2 design, short sleeves



All models with 2 side pockets, breast pocket with woven ESD symbol, grey pocket piping, lapel collar and continuously covered snap fastener.

Mixed fabric, weight 150 g/m²
67% polyester, 31% cotton and 2% conductive yarn
Machine washable up to 60°C

Available sizes: XS, S, M, L, XL, XXL, 3XL, 4XL

In compliance with ESD standard DIN EN 61340-5-1 

dpvlink 24833

Article	Type	Sleeve length	Size
Work coat GreyLine plus GL-185			
2720.GL185-P	3/4 design	long sleeves	XS-4XL
2721.GL185-P	1/2 design	long sleeves	XS-4XL
2722.GL185-P	1/2 design	short sleeves	XS-4XL



Work coat GreyLine plus GL-180



- very comfortable to wear
- hard-wearing and durable
- breathable and lightweight
- optimal ESD protection

The unisex work coat GreyLine plus 180 is available in 3 designs:



3/4 design, long sleeves

1/2 design, long sleeves

1/2 design, short sleeves



All models with 2 side pockets, breast pocket with woven ESD symbol, orange pocket piping, lapel collar and continuously covered snap fastener.

Mixed fabric, weight 150 g/m²
67% polyester, 31% cotton and 3% conductive yarn
Machine washable up to 60°C

Available sizes: XS, S, M, L, XL, XXL, 3XL

In compliance with ESD standard DIN EN 61340-5-1

[dpvlink 24834](#)

Article	Type	Sleeve length	Size
Work coat GreyLine plus GL-180			
2720.GL180-P	3/4 design	long sleeves	XS-3XL
2721.GL180-P	1/2 design	long sleeves	XS-3XL
2722.GL180-P	1/2 design	short sleeves	S-3XL



Work coat GreyLine plus GL-186



- very comfortable to wear
- hard-wearing and durable
- breathable and lightweight
- optimal ESD protection

The unisex work coat GreyLine plus 186 is available in 3 designs:

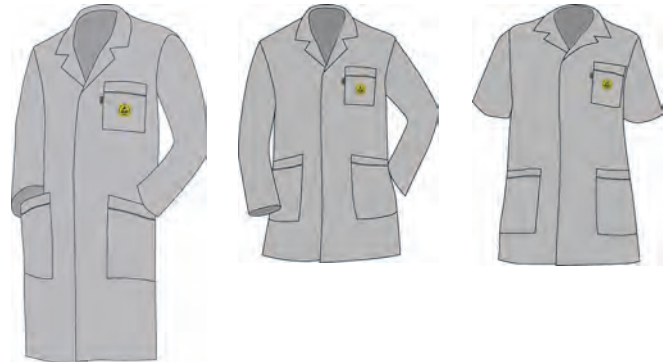

3/4 design, long sleeves

1/2 design, long sleeves

1/2 design, short sleeves



All models with 2 side pockets, breast pocket with woven ESD symbol, dark grey pocket piping, lapel collar and continuously covered snap fastener.

Mixed fabric, weight 150 g/m²
67% polyester, 31% cotton and 3% conductive yarn
Machine washable up to 60°C

Available sizes: XS, S, M, L, XL, XXL, 3XL

In compliance with ESD standard DIN EN 61340-5-1

[dpvlink 24836](#)

Article	Type	Sleeve length	Size
Work coat GreyLine plus GL-186			
2720.GL186-P	3/4 design	long sleeves	XS-3XL
2721.GL186-P	1/2 design	long sleeves	XS-3XL
2722.GL186-P	1/2 design	short sleeves	XS-3XL



BlueLine plus

Work coat BlueLine plus BL-180



- very comfortable to wear
- hard-wearing and durable
- breathable and lightweight
- optimal ESD protection

The unisex work coat BlueLine plus 180 is available in 3 designs:



3/4 design, long sleeves

1/2 design, long sleeves

1/2 design, short sleeves



All models with 2 side pockets, breast pocket with woven ESD symbol, dark blue pocket piping, lapel collar and continuously covered snap fastener.

Mixed fabric, weight 150 g/m²
67% polyester, 31% cotton and 2% conductive yarn
Machine washable up to 60°C

Available sizes: XS, S, M, L, XL, XXL, 3XL, 4XL

In compliance with ESD standard DIN EN 61340-5-1 

dpvlink 24837

Article	Type	Sleeve length	Size
Work coat BlueLine plus BL-180			
2730.BL180-P	3/4 design	long sleeves	XS-4XL
2731.BL180-P	1/2 design	long sleeves	XS-4XL
2732.BL180-P	1/2 design	short sleeves	XS-4XL



Work coat BlueLine plus BL-181



- very comfortable to wear
- hard-wearing and durable
- breathable and lightweight
- optimal ESD protection

The unisex work coat BlueLine plus 181 is available in 3 designs:



3/4 design, long sleeves

1/2 design, long sleeves

1/2 design, short sleeves



All models with 2 side pockets, breast pocket with woven ESD symbol, orange pocket piping, lapel collar and continuously covered snap fastener.

Mixed fabric, weight 150 g/m²
67% polyester, 31% cotton and 2% conductive yarn
Machine washable up to 60°C

Available sizes: XS, S, M, L, XL, XXL, 3XL

In compliance with ESD standard DIN EN 61340-5-1 

dpvlink 24838

Article	Type	Sleeve length	Size
Work coat BlueLine plus BL-181			
2730.BL181-P	3/4 design	long sleeves	XS-4XL
2731.BL181-P	1/2 design	long sleeves	S-3XL
2732.BL181-P	1/2 design	short sleeves	S-3XL



BlueLine plus Woman

Work coat BlueLine plus Woman



- very comfortable to wear
- hard-wearing and durable
- breathable and lightweight
- optimal ESD protection

The unisex work coat BlueLine plus Woman 175 is available in 3 designs:



3/4 design, long sleeves

1/2 design, long sleeves

1/2 design, short sleeves

All models with 2 side pockets, breast pocket with woven ESD symbol, dark blue pocket piping, lapel collar and continuously covered snap fastener.



Mixed fabric, weight 150 g/m²
67% polyester, 31% cotton and 2% conductive yarn
Machine washable up to 60°C

Available sizes: XS, S, M, L, XL, XXL, 3XL

In compliance with ESD standard DIN EN 61340-5-1

dpvlink 24839



Article	Type	Sleeve length	Size
Work coat BlueLine plus Woman			
2730.BLW175-P	3/4 design	long sleeves	XS-3XL
2731.BLW175-P	1/2 design	long sleeves	XS-3XL
2732.BLW175-P	1/2 design	short sleeves	XS-3XL

MyLine plus

Work coat MyLine plus



You haven't found your coat in your wished color combination yet? In this case the MyLine plus collection offers you the possibility to give the work coat your personal touch. The coat colors of the series WhiteLine plus and GreyLine plus can be combined with a colored piping that can be chosen from the below-mentioned color palette.

The high-quality, breathable and specially refined mixed fabric consists of 67% polyester, 31% cotton and 2% conductive fibers. Machine washable up to 60°C. Weight 150 g/m².



3/4 design, long sleeves

1/2 design, long sleeves

1/2 design, short sleeves

Standard color codes for pipings - Please indicate when placing an order!

Example: 2721.MyLine-P.K711.S



-Weitere Biesenfarben auf Anfrage -

dpvlink 25095



Article	Type	Sleeve length	Color	Size
2710.MyLine-P	3/4 design	long sleeves	white	XS-3XL
2711.MyLine-P	1/2 design	long sleeves	white	XS-3XL
2712.MyLine-P	1/2 design	short sleeves	white	XS-3XL

Work coat ECO-180

Work coat ECO-180

The conductive ECO-180 work coat offers reliable protection against electrostatic charge and the top-quality workmanship makes it comfortable to wear.



Work coat with long sleeves, **white**, with 2 lateral pockets, breast pocket with woven ESD warning symbol, light grey pocket piping (breast pocket), lapel collar and completely covered snap fastener.

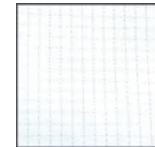

Work coat with long sleeves, **grey**, with 2 lateral pockets, breast pocket with woven ESD warning symbol, dark grey pocket piping (breast pocket), lapel collar and completely covered snap fastener.



Work coat with long sleeves, **blue**, with 2 lateral pockets, breast pocket with woven ESD warning symbol, light grey pocket piping (breast pocket), lapel collar and completely covered snap fastener.



Material: 68% polyester, 30% cotton and 2% carbon fibers; 5 mm grid

Machine washable up to 60° C

In compliance with the ESD standard DIN EN 61340-5-1 

Available sizes: XS, S, M, L, XL, XXL, 3XL, 4XL, 5XL

[dpvlink 19660](#)

Article	Sleeve length	Color	Size
2701.ECO180	long sleeves	white	XS-5XL
2702.ECO180	long sleeves	grey	XS-5XL
2703.ECO180	long sleeves	blue	XS-5XL



Work coat AM-161 plus

The dissipative work coat AM-161 plus offers a reliable protection against electrostatic charge and is comfortable to wear. The high-quality, light (weight 160g/m²), breathable and specially finished mixed fabric consists of 63% polyester, 35% cotton and 2% conductive yarn. Machine washable up to 60°C.

Entspricht der ESD-Norm DIN EN 61340-5-1 



1/2 design, short sleeves



3/4 design, long sleeves



Our clothes have especially been developed for the requirements in electronics manufacturing. All products marked with this sign are tested and certified by the Sächsischen Textilforschungsinstitut e.V (stfi) according to EN 61340-5-1.

Work coat AM-161 plus standard



Long sleeves, 3/4 design, with 2 side pockets, breast pocket with woven ESD symbol, continuously covered snap fastener.

In compliance with the ESD standard DIN EN 61340-5-1 

Available sizes: XS, S, M, L, XL, XXL, 3XL, 4XL, 5XL

[dpmlink 16344](#)



Article	Color	Size
Work coat AM-161 plus standard		
2610.AM161	white	XS-5XL
2630.AM161	blue	XS-5XL

Work coat AM-161 plus with short sleeves



Short sleeves, 1/2 design (short coat), with 2 side pockets, breast pocket with woven ESD symbol, continuously covered snap fastener. The model in white/blue has a collar and a breast pocket of contrasting blue.

In compliance with the ESD standard DIN EN 61340-5-1 

Available sizes: S, M, L, XL, XXL, 3XL, 4XL

[dpmlink 16348](#)



Article	Color	Size
Work coat AM-161 plus with short sleeves		
2640.AM161-K	white / blue	S-4XL
2641.AM161-K	white	S-4XL
2642.AM161-K	blue	S-4XL

Work coat AM-140

The dissipative coat AM-140 offers a reliable protection against electrostatic charge and is comfortable to wear. The high-quality, light, breathable and specially finished mixed fabric consists of 63% polyester, 34% cotton and 3% conductive yarn. Machine washable up to 60°C. Weight 140 g/m².



3/4 design,
long sleeves



3/4 design,
short sleeves

Work coat AM 140 with long sleeves



Long sleeves, 3/4 design with 2 side pockets, breast pocket with woven ESD symbol, continuously covered snap fastener.

In compliance with the ESD standard DIN EN 61340-5-1 

Available sizes: XS, S, M, L, XL, XXL, 3XL, 4XL

dpvlink 5812



Article	Color	Size
Work coat AM 140 with long sleeves		
2610.AM140	white	XS-4XL
2630.AM140	blue	XS-4XL

Work coat AM140-K short sleeves



Short sleeves, 3/4 design with 2 side pockets, breast pocket with woven ESD symbol, continuously covered snap fastener.

In compliance with the ESD standard DIN EN 61340-5-1 

Available sizes: XS, S, M, L, XL, XXL, 3XL

dpvlink 1374



Article	Color	Size
Work coat AM140-K short sleeves		
2610.AM140-K	white	XS-3XL
2630.AM140-K	blue	S-3XL

Work coat AM-120

The dissipative coat AM-120 offers a reliable protection against electrostatic charge and is comfortable to wear. The high-quality, very light polyester fabric is made of 98% polyester and 2% conductive yarn. Machine washable up to 40°C. Weight 120 g/m².

Work coat AM-120



Long sleeves, 3/4 design with 2 side pockets, conductive 4 mm grid, polyester fabric (98% polyester, 2% carbonized yarn), breast pocket with woven ESD symbol, continuously covered snap fastener. Machine washable up to 40°C, weight 120 g/m². Suitable for clean production areas.

In compliance with the ESD standard DIN EN 61340-5-1 

Available sizes: S, M, L, XL, XXL, 3XL

dpvlink 8294

Article	Color	Size
Work coat AM-120		
2760.AM120	white	S-3XL



Reusable cap Type HB 120



- Reusable cap
- color white
- material: 98% polyester, 2% carbonized yarn
- suitable for clean production areas
- cleanroom class 100 (ISO 5)
- PU = 10 pieces

In compliance with the ESD standard DIN EN 61340-5-1 

dpvlink 8291

Article	Type	Color
2760.HB120	Reusable cap Type HB-120	white



You find suitable **reusable overshoes type PB-120** made of the same material under **dpvlink 8286**.

AM-110 extra lightweight

Work coat AM-110 extra lightweight



Long sleeves, 3/4 design, with 2 side pockets, conductive 4-mm grid, dissipative cotton mixed fabric (50% polyester, 47% cotton, 3% carbonized yarn), breast pocket with embroidered ESD logo, snap fastener, machine washable up to 60°C, weight 110g/m². Suitable for clean production areas.

In compliance with the ESD standard DIN EN 61340-5-1 

Available sizes: XS, S, M, L, XL, XXL, 3XL, 4XL, 5XL

dpvlink 21215

Article	Color	Size
Work coat AM-110 extra lightweight		
2760.AM110	white	XS-3XL
2760.AM110-1.4XL	white	4XL
2760.AM110-1.5XL	white	5XL



T-Shirt Uni



T-Shirt Uni, electrostatically dissipative, breathable, with integrated conductive fibers, sleeve with ESD logo, machine washable up to 40°C.
Cotton mixed fabric: 97% cotton, 3% conductive yarn, weight 150 g/m²
In compliance with the ESD standard DIN EN 61340-5-1 



dpvlink 14315



Article	Style	Color	Size
T-Shirt Uni			
2658.T010	T-shirt	white	XS-3XL
2658.T210	T-shirt	dark blue	XS-6XL
2658.T210-V	T-shirt / V-neck	dark blue	XS-5XL
2658.T610	T-shirt	black	XS-6XL
2658.T610-V	T-shirt / V-neck	black	XS-5XL
2658.T910	T-shirt	royal blue	XS-6XL
2658.T410-V	T-shirt / V-neck	anthracite	XS-6XL

T-Shirt Uni High Quality



T-shirt Uni, electrostatically dissipative, breathable, with conductive inwoven fibers, sleeves with ESD logo, machine washable up to 40°C. High-quality TOP product with excellent wearing comfort.
Cotton mixed fabric: 97% cotton, 3% conductive yarn, weight 195g/m²
In compliance with the ESD standard DIN EN 61340-5-1 

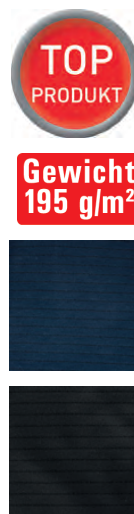

Gewicht 195 g/m²

dpvlink 17640



Article	Color	Size
T-Shirt Uni High Quality		
2658.T0611	black	XXS-4XL
2658.T0211	dark blue	XS-5XL

T-shirt



T-Shirt, electrostatically dissipative, breathable, with conductive yarn, sleeve with ESD logo, machine washable up to 40°C.
Cotton mixed fabric: 97% cotton, 3% conductive yarn, weight 150 g/m²
In compliance with the ESD standard DIN EN 61340-5-1 



dpvlink 6742



Article	Color	Size
T-shirt		
2655.T	grey / dark blue	XS-3XL
2657.T	blue / dark blue	XS-4XL

Lady Shirt



Women's T-Shirt or tank top fitted with V neck, electrostatically dissipative. Breathable, with conductive carbon fibers, ESD logo on sleeve or seam, machine washable up to 40°C.
Cotton mixed fabric: 97% cotton, 3% conductive yarn (carbon), weight 150g/m²
In compliance with the ESD standard DIN EN 61340-5-1 



dpvlink 19845



Article	Style	Color	Size
Lady Shirt			
2658.TL210	T-shirt / V-neck	dark blue	XS-4XL
2658.TT215	Tank Top / V-neck	dark blue	XS-4XL
2658.TT615	Tank Top / V-neck	black	XS-4XL
2658.TL610	T-shirt / V-neck	black	XS-4XL

Polo shirt Lady



Polo shirt Lady, electrostatically dissipative, slightly tapered; breathable, conductive fibers, sleeve with ESD logo, machine washable up to 40°C.

Cotton mixed fabric: 96% cotton, 4% conductive yarn, weight 150 g/m²

In compliance with the ESD standard DIN EN 61340-5-1 ⚠️



Tapered cut (close-fitting), short sleeves with slight gathers on the transition to the shoulder, collar with button placket (5 buttons), rounded waistband with lateral insert, stylish colors:



dpvlink 14477

Article	Color	Size
Polo shirt Lady		
2658.PL610	black	XS-4XL
2658.PL010	white	XS-3XL
2658.PL210	dark blue	XS-4XL



Polo shirt Uni



Polo shirt Uni, electrostatically dissipative. Collar with button placket, breathable, with conductive yarn, sleeve with ESD logo, machine washable up to 40°C. Cotton mixed fabric: 96% cotton, 4% conductive yarn, weight 210 g/m²

In compliance with the ESD standard DIN EN 61340-5-1 ⚠️

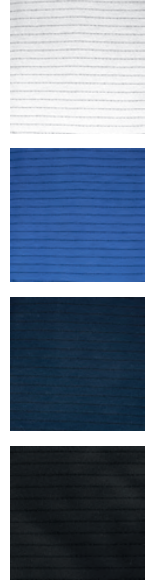

dpvlink 14319

Article	Color	Size
Polo shirt Uni		
2670.P010	white	XS-4XL
2670.P210	dark blue	XS-5XL
2670.P610	black	XS-5XL
2670.P910	cornflower blue	XS-4XL



Polo shirt



Polo shirt, electrostatically dissipative, collar with button placket, breathable, with conductive fibers, sleeve with ESD logo, machine washable up to 40°C.

Mixed fabric: 50% cotton, 47% polyester, 3% conductive yarn, weight 210g/m²

Entspricht der ESD-Norm DIN EN 61340-5-1 ⚠️

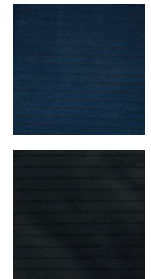

dpvlink 16382

Article	Color	Size
Polo shirt		
2628.P615	black	XS-5XL
2628.P215	dark blue	XS-5XL



Polo shirt



Polo shirt, electrostatically dissipative. Collar with button placket, breathable, conductive yarn, breast pocket with ESD logo, machine washable up to 40°C.

- Grey with contrasting dark blue collar, breast pocket and sleeves
- Blue with contrasting black collar, breast pocket and sleeves

Mixed fabric: 50% cotton, 47% polyester, 3% conductive yarn, weight 210 g/m²

In compliance with the ESD standard DIN EN 61340-5-1 



dpvlink 154

Article	Color	Size
Polo shirt		
2625.P	grey / dark blue	XS-4XL
2627.P	blue / black	XS-4XL



Polo shirt long sleeves



Polo shirt with long sleeves, dissipative. Collar with button placket, breathable, with conductive yarn, breast pocket with ESD symbol, machine washable up to 40°C

- blue with contrasting black collar, breast pocket and sleeves
- grey with contrasting dark blue collar, breast pocket and sleeves
- black with black collar, breast pocket and sleeves

Mixed fabric: 50% cotton, 47% polyester, 3% conductive yarn, weight 210 g/m²

In compliance with the ESD standard DIN EN 61340-5-1 



dpvlink 5885

Article	Color	Size
Polo shirt long sleeves		
2647.P	blue / black	XS-4XL
2645.P	grey / dark blue	XS-4XL
2647.P615	black	XS-4XL



Sweatshirt



Sweatshirt, electrostatically dissipative. Round neck, breathable, comfortable to wear, unisex design, 1/2 design, ESD symbol on the sleeve, machine washable up to 40°C

Mixed fabric: 48% polyester, 48% cotton, 4% conductive yarn, weight 280 g/m²

In compliance with the ESD standard DIN EN 61340-5-1 

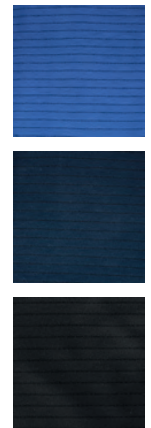

dpvlink 16239

Article	Color	Size
Sweatshirt		
2671.S210	dark blue	XXS-4XL
2671.S610	black	XXS-4XL
2671.S910	royal blue	XXS-4XL



Sweat jacket



Sweat jacket with covered zipper. Electrostatically dissipative, breathable, comfortable to wear, unisex model, 1/2 design, ESD symbol on the sleeve, 2 pockets, machine washable up to 40°C.

Mixed fabric: 48% polyester, 48% cotton, 4% conductive yarn, weight 280 g/m²

In compliance with the ESD standard DIN EN 61340-5-1 

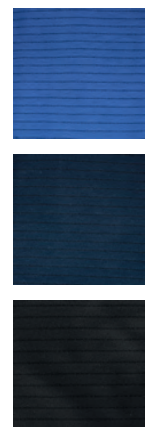

dpvlink 16243

Article	Color	Size
Sweat jacket		
2671.SJ210	dark blue	XXS-4XL
2671.SJ610	black	XXS-5XL
2671.SJ910	royal blue	XXS-4XL



Sweatshirt Premium



Sweatshirt Premium, electrostatically dissipative. Round neck, breathable, comfortable to wear, unisex design, 1/2 design, ESD symbol on the sleeve, machine washable up to 40°C.

Mixed fabric 240 g/m² (46% polyester, 50% cotton, 4% carbonized yarn)

In compliance with the ESD standard DIN EN 61340-5-1 



dpvlink 21346

Article	Color	Size
Sweatshirt Premium		
2672.S215	dark blue	XXS-5XL
2672.S615	black	XXS-5XL



Sweat jacket Premium



Sweat jacket Premium, electrostatically dissipative. Zipper, breathable, comfortable to wear, unisex design, 1/2 design, ESD symbol on the sleeve, 2 pockets, machine washable up to 40°C.

Mixed fabric 240 g/m² (46% polyester, 50% cotton, 4% carbonized yarn)

In compliance with the ESD standard DIN EN 61340-5-1 



dpvlink 21349

Article	Color	Size
Sweat jacket Premium		
2672.SJ215	dark blue	XXS-5XL
2672.SJ615	black	2XS-5XL



Sweatshirt



Electrostatically dissipative mixed fabric (43% polyester, 50% cotton, 7% conductive yarn), light, breathable, comfortable to wear, fabric with conductive fibers, unisex model, 1/2 design, ESD symbol on the left upper arm, machine washable up to 40°C, weight 270 g/m²

In compliance with the ESD standard DIN EN 61340-5-1 



dpvlink 10272

Article	Color	Size
Sweatshirt		
2671.SS.B	blue	S-3XL



Sweat jacket



Sweat jacket, electrostatically dissipative mixed fabric (43% polyester, 50% cotton, 7% conductive yarn), continuous zipper, conductive cuffs, comfortable to wear, light, breathable, unisex model, 1/2 design, ESD symbol on the left upper arm, machine washable up to 40°C, weight 290 g/m²

In compliance with the ESD standard DIN EN 61340-5-1 



dpvlink 20092

Article	Color	Size
Sweat jacket		
2670.SJ.BL	black	XS-3XL
2670.SJ.BL-1	black	4XL-5XL
2671.SJ.B	blue	XS-3XL
2671.SJ.B-1	blue	4XL-5XL



ESD sweat jacket



Electrostatically dissipative sweatshirt and sweat jacket; mixed fabric (48% polyester, 48% cotton, 4% conductive yarn), lime-green with collar and cuffs in contrasting black, unisex version, EPA-logo on the left upper arm, machine washable up to 40°C. In compliance with the ESD standard DIN EN 61340-5-1 



[dpvlink 24934](#)

Article	Style	Color	Size
DPV-1250	Sweat jacket	lime-green	XS-4XL



EPAstore® – Individual Packaging Solutions

Our online tools for you: for quick and easy specification of the interlayers and parting inserts you require.

Choose from the standard solutions displayed directly or use the integrated inquiry function.

No need to download an application – works on PC, laptop or smartphone.



Configurator for interlayers



[dpvlink: KonZ](#) 

for partitions/parting inserts



[dpvlink: KonG](#) 

Visit us online and configure your packaging solution with ease

- Simple operation and direct request via the tool
- Immediate visualization of your desired product
- Standard or individual solutions
- Browser-controlled tool for pc, tablet or smartphone
- Large selection of materials and material thicknesses



Coolmax® ALL SEASON



COOLMAX®
ALL SEASON TECHNOLOGY

Coolmax® ALL SEASON with freshPRO technology is a multifunctional high-tech fabric combining several characteristics. It offers its wearer a perfect wearing comfort adapted to the respective degree of temperature and activity.

- perfectly adapted to changing climatic conditions
- pleasant and comfortable to wear
- easy to care and machine washable
- dissipative

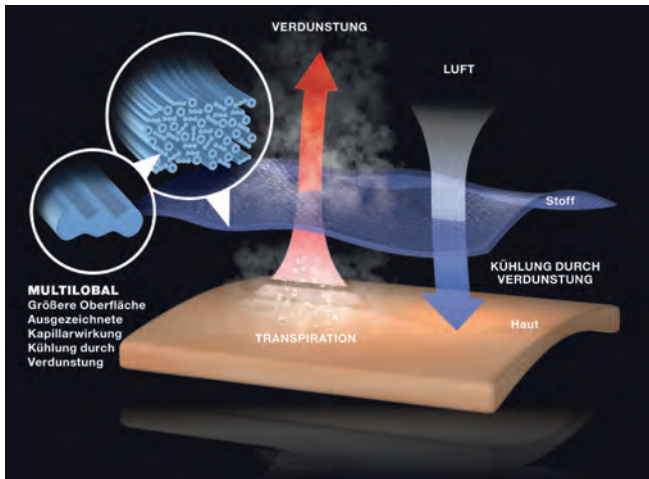

Higher temperatures and increased activity produce a comfortable evaporative cooling.

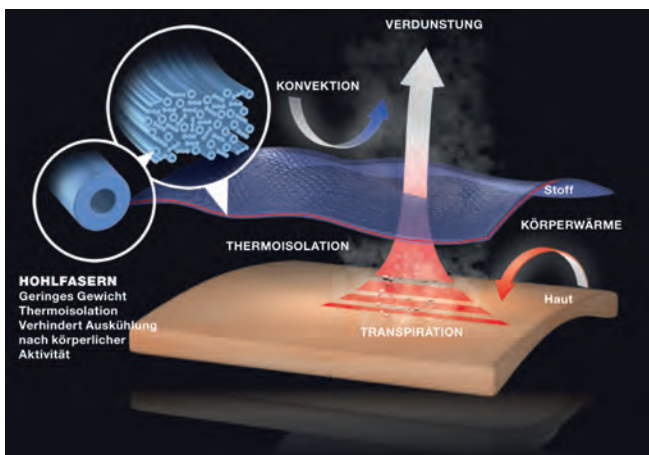

Lower temperatures and activity produce a protective thermal-insulating effect.

Polo shirt Coolmax® ALL SEASON



Polo shirt Coolmax® ALL SEASON with high electrostatic dissipation, weight 160 g/m² for ESD protected work areas, soft, light and breathable, comfortable to wear.

Mixed fabric: 96% Coolmax® ALL SEASON, 4% conductive yarn

In compliance with the ESD standard DIN EN 61340-5-1 ⚠



- keeps the skin cool and preserves the well-being
- moisture is transported away from the body
- dry wear climate
- easy-care, machine washable
- dissipative

COOLMAX®
ALL SEASON TECHNOLOGY

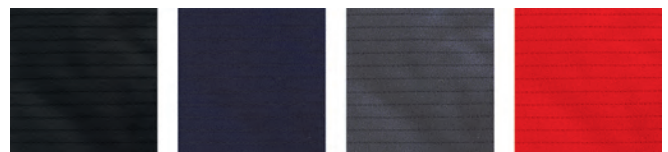

dpvlink 16371

Article	Style	Color	Size
Polo shirt Coolmax® ALL SEASON			
2680.P6525	polo shirt / short sleeves	red	XS-4XL
2680.P6527	polo shirt / short sleeves	anthracite	XS-4XL
2680.P6522	polo shirt / short sleeves	dark blue	XS-4XL
2680.P6526	polo shirt / short sleeves	black	XS-4XL
2680.P6537	polo shirt / long sleeves	anthracite	XS-4XL
2680.P6532	polo shirt / long sleeves	dark blue	XS-4XL
2680.P6536	polo shirt / long sleeves	black	XS-4XL



T-Shirt Coolmax® ALL SEASON



dpvlink 25464

Article	Style	Color	Size
T-Shirt Coolmax® ALL SEASON			
2680.T6517	T-shirt	anthracite	XS-4XL
2680.T6512	T-shirt	dark blue	XS-4XL
2680.T6516	T-shirt	black	XS-4XL



Polo shirt Lady Coolmax® ALL SEASON



Figure-hugging women's polo shirt Coolmax® ALL SEASON very dissipative, short sleeves, weight 160g/m², for ESD-protected areas, soft, lightweight and breathable, comfortable to wear.

Mixed fabric: 96% Coolmax® ALL SEASON, 4% conductive yarn

In compliance with the ESD standard DIN EN 61340-5-1 



- keeps cool and saves well-being
- directs moisture away from the body
- dry wearing comfort
- easy to care and machine-washable
- dissipative

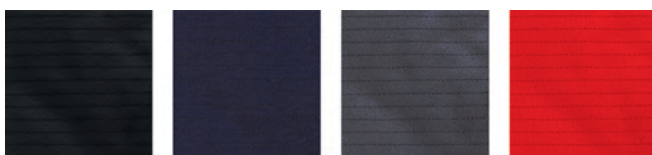

[dpvlink 19498](#)

Article	Color	Size
Polo shirt Lady Coolmax® ALL SEASON		
2680.P5525	red	XS-2XL
2680.P5527	anthracite	XS-2XL
2680.P5522	dark blue	XS-4XL
2680.P5526	black	XS-2XL



Sweatshirt / sweat jacket Coolmax® ALL SEASON



Sweatshirt / sweat jacket Coolmax® ALL SEASON very dissipative, weight 230 g/m² for ESD protected work areas, soft, light and breathable, comfortable to wear.

Mixed fabric: 84% Coolmax® ALL SEASON, 10% conductive yarn, 6% Lycra

In compliance with the ESD standard DIN EN 61340-5-1 



- keeps cool and saves well-being
- directs moisture away from the body
- dry wearing comfort
- easy to care and machine-washable
- dissipative

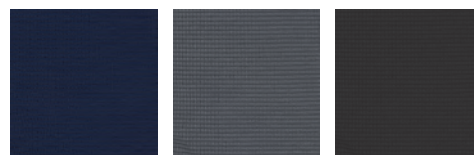

[dpvlink 16377](#)

Article	Style	Color	Size
Sweatshirt / sweat jacket Coolmax® ALL SEASON			
2685.S6557	Sweatshirt / V-neck	anthracite	XS-4XL
2685.S6552	Sweatshirt / V-neck	dark blue	XS-4XL
2685.S6567	Sweatshirt / lapel collar with zipper	anthracite	XS-4XL
2685.S6562	Sweatshirt / lapel collar with zipper	dark blue	XS-4XL
2685.SJ6577	Sweat jacket	anthracite	XS-4XL
2685.SJ6572	Sweat jacket	dark blue	XS-4XL
2685.SJ6576	Sweat jacket	black	XS-4XL



Women's sweat jacket Coolmax® ALL SEASON



[dpvlink 22323](#)

Article	Style	Color	Size
Women's sweat jacket Coolmax® ALL SEASON			
2685.SJ5577	Sweat jacket	anthracite	XS-2XL
2685.SJ5572	Sweat jacket	dark blue	XS-2XL
2685.SJ5576	Sweat jacket	black	XS-2XL



PremiumSmooth

PremiumSmooth is a NEWLY developed functional textile. Its high-quality inside **adapts softly** to the skin - ensuring therefore an extremely comfortable wearing. The **breathable and moisture-absorbing** micro polyester on the exterior ensures optimal thermal regulation. The result of the EPAwear® PremiumSmooth shirts stands for itself: Smooth comfort combined with **optimal ESD protection**.



T-Shirt / Polo shirt PremiumSmooth

- high electrostatic dissipation
- weight 180g/m²
- for ESD protected working areas
- soft, light and breathable
- very comfortable to wear

PremiumSmooth functional fabric:

47% cotton inside
46% micro polyester outside
7% conductive fibers

Available in the 2 standard colors black and dark blue.
Your requested color is possible when ordering at least 300 pieces.
With the new innovative PremiumSmooth textile, the new generation of Polo and T-Shirts offers everything a TOP product needs:

- TOP industrial quality
- extremely durable textile
- **extremely comfortable wearing**
- breathable fabric
- pleasant wearing
- wellbeing on the skin
- excellent dissipation values
- Active cold and heat regulation
- timeless cut
- machine washable up to 30°C



Polo shirt Lady PremiumSmooth



Polo shirt PremiumSmooth with high electrostatic dissipation, Premium Smooth fabric (47% cotton inside / 47% micro polyester outside / 7% conductive fibers), weight 180g/m², soft, light and breathable, very comfortable to wear.

In compliance with the ESD standard DIN EN 61340-5-1 



dpvlink 17851



Article	Color	Size
Polo shirt Lady PremiumSmooth		
2675.PL7542	dark blue	XS-3XL
2675.PL7546	black	XS-3XL

Polo shirt PremiumSmooth



Polo shirt PremiumSmooth with high electrostatic dissipation, Premium Smooth fabric (47% cotton inside / 47% micro polyester outside / 7% conductive fibers), weight 180g/m²; soft, light and breathable, very comfortable to wear.

In compliance with the ESD standard DIN EN 61340-5-1 



dpvlink 17850



Article	Color	Size
Polo shirt PremiumSmooth		
2675.P7532	dark blue	S-4XL
2675.P7537	anthracite	S-4XL
2675.P7536	black	S-4XL

Polo shirt PremiumSmooth with long sleeves

Highly dissipative polo shirt PremiumSmooth with long sleeves, Premium Smooth fabric (47% cotton inside / 46% micro polyester outside / 7% conductive fibers), weight 180g/m²; soft, light and breathable, very comfortable to wear.

In compliance with the ESD standard DIN EN 61340-5-1 



dpvlink 27216

Article	Color	Size
Polo shirt PremiumSmooth with long sleeves		
2675.P7532-LA	dark blue	XS-4XL
2675.P7536-LA	black	XS-4XL



T-Shirt Lady PremiumSmooth



T-shirt Lady PremiumSmooth with high electrostatic dissipation, Premium Smooth fabric (47% cotton inside / 47% micro polyester outside / 7% conductive fibers), weight 180g/m², with stylish V-neck; soft, light and breathable, very comfortable to wear.

In compliance with the ESD standard DIN EN 61340-5-1 



EPA®wear

smooth
premium

dpvlink 17853

Article	Color	Size
T-Shirt Lady PremiumSmooth		
2675.TL7422	dark blue	XS-3XL
2675.TL7426	black	XS-3XL



T-Shirt PremiumSmooth



T-shirt PremiumSmooth with high electrostatic dissipation, PremiumSmooth fabric (47% cotton inside / 47% micro polyester outside / 7% conductive fibers), weight 180g/m²; soft, light and breathable, very comfortable to wear.

In compliance with the ESD standard DIN EN 61340-5-1 



EPA®wear

smooth
premium

dpvlink 17852

Article	Color	Size
T-Shirt PremiumSmooth		
2675.T7412	dark blue	S-4XL
2675.T7416	black	S-4XL



ESD Winter vest type 1600



Vest without sleeves, dissipative material (31% polyester, 66% cotton, 3% conductive yarn); unisex version; inside completely with quilted lining, drawstring at hem, panel seams with insertion pockets, 1 breast pocket with zipper, stand-up collar, EPA logo on bottom hem; machine washable up to 40°C.

In compliance with the ESD standard DIN EN 61340-5-1 
(standard only fulfilled in connection with further ESD-compliant clothing)



[dpvlink 21228](#)

Article	Color	Size
ESD Winter vest type 1600		
DPV-1600	graphite	XS-XL
DPV-1600-1	graphite	2XL-4XL



ESD Winter jacket



ESD winter jacket, material (62% polyester, 34% cotton, 4% conductive yarn) electrostatically dissipative, warming fleece lining; water-repellent, unisex version, EPA logo on the left breast, machine washable up to 40°C.

In compliance with the ESD standard DIN EN 61340-5-1 



[dpvlink 19465](#)

Article	Color	Size
ESD Winter jacket		
DPV-1066	black	XS-2XL
Sizes 3XL to 5XL on request		



ESD Winter vest type 1000



Men's winter vest without sleeves, upper material dissipative (98% polyester, 2% conductive yarn) water-repellent, lining of warming cotton fleece, unisex, EPA logo on the left breast, machine washable up to 60°C.

In compliance with the ESD standard DIN EN 61340-5-1 
(standard only fulfilled in connection with further ESD-compliant clothing)



[dpvlink 19463](#)

Article	Color	Size
ESD Winter vest type 1000		
DPV-1000	dark blue	XS-2XL



Sizes 3XL to 5XL on request

ESD Winter jacket



Men's winter vest with long sleeves, upper material dissipative (98% polyester, 2% conductive yarn); warming fleece lining; unisex; EPA-logo on the left breast, machine washable up to 40°C. In compliance with the ESD standard DIN EN 61340-5-1



[dpvlink 19652](#)

Article	Color	Size
ESD Winter jacket		
DPV-1010	dark blue	XS-2XL



Sizes 3XL to 6XL on request

ESD functional jacket Premium



Two-layered jacket, thermofleece, continuous zipper, ESD logo, two side pockets with zipper, internal pockets, machine washable up to 40°C.

In compliance with the ESD standard DIN EN 61340-5-1 



dpvlink 27075

Article	Color	Size
ESD functional jacket Premium		
DPV-1800	dark grey / black	S-XL
DPV-1800-1	dark grey / black	2XL-3XL



ESD Softshell jacket in signal color



ESD softshell jacket; material (98% polyester, 2% conductive yarn) electrostatically dissipative; breathable; internal layer Softshell; unisex version; EPA-logo on the left breast, machine washable up to 40°C. In compliance with the ESD standard DIN EN 61340-5-1



dpvlink 19656

Article	Color	Size
DPV-1031	orange	XS-2XL
DPV-1030	neon yellow	XS-2XL



Sizes 3XL to 5XL on request

ESD High-visibility vest



Our yellow high visibility vest is an essential protective tool for anyone working in environments where increased visibility and ESD capability are required. Made from high quality polyester with conductive fibers, it not only provides good visibility and safety in EPA zones but also comfort and durability.



The vest is equipped with fluorescent material and two large reflective strips that run around the waist and back, ensuring that you are clearly visible even in poor lighting conditions. The vest meets and is tested according to the requirements of protection class 1 in accordance with EN ISO 20471:2013 PPE (personal protective equipment).

It is securely fastened with two internal Velcro fasteners and fits perfectly over your regular clothing thanks to its straight cut and chest circumference. Choose safety, visibility and ESD protection with our tested and certified high-visibility vest for professional use.



Material:
Polyester 97%, conductive fibers 3%, weight 120 g/m²

In compliance with the ESD standard DIN EN 61340-5-1 

dpvlink 19397

Article	Color	Size
DPV-1026	yellow	S-2XL



Sizes 3XL to 5XL on request

Trousers ESD BlackLine



The functional ESD working trousers have many pockets for tools. So everything is always within reach. At the same time the trousers are very comfortable to wear due to the laterally elastic Flexbelt® seam.



ESD trousers BlackLine

- electrostatically dissipative
- ESD logo
- weight 180 g/m²
- color black
- sizes XS to 2XL (men's cut)
- Flexbelt® waistband very elastic and comfortable to wear
- belt loops

In compliance with the ESD standard DIN EN 61340-5-1

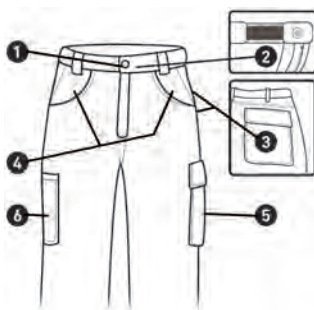

Highlights

1. Covered waistband fastener inside
2. Flexbelt® waistband for high wearing comfort
3. 2x back pockets with flap and velcro fastener
4. 2x large pockets
5. Large thigh pocket with flap and velcro fastener
6. Ruler pocket

Material: 65% polyester, 33% cotton, 2% carbon

Available sizes: XS, S, M, L, XL, 2XL

dpvlink 23201

Article	Color	Size	Type	Fabric weight g/qm
Trousers ESD BlackLine				
2770.BK150N	black	XS-2XL	long	180
2770.BK151N	black	XS-2XL	short	180



ESD Cap



ESD cap; material (48% polyester, 48% cotton, 4% conductive yarn) electrostatically dissipative, unisex version; one size fits all; EPA labeling at the front, machine washable up to 40°C. In compliance with the ESD standard DIN EN 61340-5-1. Available in light blue with 210 g/m² or in dark blue with 210 g/m² or with 280 g/m².



dpvlink 21079

Article	Color	Fabric weight g/qm
ESD Cap		
DPV-1080	dark blue	280
DPV-1081	dark blue	210
DPV-1082	light blue	210



ESD Loop scarf



ESD loop scarf; electrostatically dissipative



- material
 - 96% cotton
 - 4% conductive yarn
- unisex version
- one size fits all
- available in dark blue and black
- machine washable up to 40°C
- In compliance with the ESD standard DIN EN 61340-5-1

dpvlink 22695

Article	Color	Fabric weight g/qm
ESD Loop scarf		
DPV-1085	dark blue	150
DPV-1085.B	black	150



ESD Scarf



ESD scarf; electrostatically dissipative



- material
 - 96% cotton
 - 4% conductive yarn
- unisex version
- one size fits all
- available in dark blue and black
- dimensions 185 x 30 cm
- machine washable up to 40°C
- In compliance with the ESD standard DIN EN 61340-5-1

dpvlink 22930

Article	Color	Fabric weight g/qm
ESD Scarf		
DPV-1086	dark blue	150
DPV-1086.B	black	150



Cleanroom clothing

Cleanroom overalls



DPV cleanroom overalls suitable for cleanrooms and ESD-safe
Material: 110 g/m² (98 % polyester and 2% conductive fibers)

- lapel collar
- covered zipper
- raglan sleeves
- knitted cuffs on arms
- adjustable snaps on legs
- adjustable buttonhole elastic in waist
- snap counterpart for hood
- clip band dispositive for name labeling
- name tape has to be ordered separately
- thigh pocket with flap on the right
- antistatic 
- usable up to cleanroom class ISO 4 (class 10)

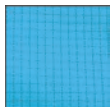

On request also available in light blue.

dpvlink 21424

Article	Color	Size
Cleanroom overalls		
1010.RR-101	white	S-XXL
1010.RR-201	light blue	S-XXL

Sizes 3XL to 5XL on request

Cleanroom all-around protection hood



- Zipper in front
- with shoulder cover
- adjustment possible with buckle on the back
- large head harness
- snap fixture for mask
- ear insert
- antistatic 
- usable up to cleanroom class ISO 4 (class 10)

dpvlink 21432

Article	Color	Size
1010.RR-107	white	S-XXL
1010.RR-207	light blue	S-XXL

Cleanroom mask



- for buttoning in the all-around protection hood
- antistatic 
- usable up to cleanroom class ISO 4 (class 10)

dpvlink 21444

Article	Color	Size
1010.RR-108	white	one size
1010.RR-208	light blue	one size

Cleanroom coat



DPV cleanroom coat suitable for cleanrooms and ESD-safe
Material: 110 g/m² (98 % polyester and 2% conductive fibers)

- lapel collar
- snaps in front
- raglan sleeves
- clip band fixture for name labeling
- name tape has to be ordered separately
- knitted cuffs on arms
- 1 breast pocket
- 2 hip pockets
- antistatic 
- usable up to cleanroom class ISO 4 (class 10)

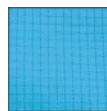

On request also available in light blue.

dpvlink 21428

Article	Color	Size
Cleanroom coat		
1010.RR-102	white	S-XXL
1010.RR-202	light blue	S-XXL

Sizes 3XL to 5XL on request

Cleanroom overboot



- high version
- plastic outsole
- with zipper
- clip fastener over instep for optimal fit
- antistatic 
- usable up to cleanroom class ISO 4 (class 10)

dpvlink 21441

Article	Color	Size
1010.RR-112	white	S-XXL
1010.RR-212	light blue	S-XXL

Cleanroom overshoe



- angle-high
- plastic outsole
- elastic
- antistatic 
- usable up to cleanroom class ISO 4 (class 10)

dpvlink 21438

Article	Color	Size
Cleanroom overshoe		
1010.RR-114	white	S-XXL
1010.RR-214	light blue	S-XXL

Disposable gauntlets Tyvek IsoClean 



Gauntlets with inside seams, 45 cm long, covered elasticated cuffs and biceps.

- Certified according to Regulation (EU) 2016/425
- Partial body protection, category III, type PB [6-B]
- EN 14126 (protective clothing against infectious agents)
- Suitable for GMP class C/D clean-rooms (ISO class 6-9)

dpvlink 28441

Article	Color	Size
1001.010	white	one size



Disposable gauntlets Tyvek IsoClean

Sterile version on request

Disposable hood Tyvek IsoClean 



Tyvek® hood

- Certified according to Regulation (EU) 2016/425
- Partial body protection, category III, type PB [6-B]
- EN 14126 (protective clothing against infectious agents)
- Suitable for GMP class C/D clean-rooms (ISO class 6-9)

dpvlink 28443

Article	Color
1001.011	white



Disposable hood Tyvek IsoClean

Sterile version on request

Disposable hood Tyvek IsoClean 



Hood with Tyvek® straps

- Certified according to Regulation (EU) 2016/425
- Partial body protection, category III, type PB [6-B]
- EN 14126 (protective clothing against infectious agents)
- Suitable for GMP class C/D clean-rooms (ISO class 6-9)

dpvlink 28445

Article	Color	Size
1001.012	white	one size



Disposable hood Tyvek IsoClean

Sterile version on request

Disposable overshoe/boot Tyvek IsoClean





Overshoes/boots with slip-resistant Tyvek® sole

- Certified according to Regulation (EU) 2016/425
- Partial body protection, category III, type PB [6-B]
- EN 14126 (protective clothing against infectious agents)
- Suitable for GMP class C/D cleanrooms (ISO class 6-9)

dpvlink 28447

Article	Color	Size
1001.020	white	M-L
1001.025	white	M-L



Disposable overshoe/boot Tyvek IsoClean

Sterile version on request

Disposable coat Tyvek IsoClean





Coat with edged neckline, serged seams, waistband from center front waist

- Certified according to Regulation (EU) 2016/425
- Partial body protection, category III, type PB [6-B]
- EN 14126 (protective clothing against infectious agents)
- Suitable for GMP class C/D clean-rooms (ISO class 6-9)

dpvlink 28451

Article	Color	Size
1001.040	white	1-2



Disposable coat Tyvek IsoClean

Sterile version on request

Disposable coat Tyvek IsoClean





Coat with edged neckline, internal seams, covered elastic bands on sleeves and snap

- Certified according to Regulation (EU) 2016/425
- Partial body protection, category III, type PB [6-B]
- EN 14126 (protective clothing against infectious agents)
- Suitable for GMP class C/D clean-rooms (ISO class 6-9)

dpvlink 28453

Article	Color	Size
1001.045	white	S-3XL



Disposable coat Tyvek IsoClean

Sterile version on request

Disposable coat Tyvek IsoClean



Coat with collar and Velcro fastener at the neck. Opening at the back closure. Edged waist bands.

- Certified according to Regulation (EU) 2016/425
- Chemical protective clothing category III, partial body protection type PB [6-B]
- EN 14126 (protective clothing against infectious agents)
- Suitable for GMP class C/D cleanrooms (ISO class 6-9)

dpvlink 28455

Article	Color	Size
1001.050	white	XS-3XL

Disposable coat Tyvek IsoClean
Sterile version on request



Protective clothes ESD UVEX®

Disposable suit 3B chem light



Protection against several inorganic chemicals in low concentration. Does not contain any halogen compounds, can thus be disposed without further residues that harm the environment or health.

- high wearing comfort due to lightweight and breathable material with skin-friendly non-woven material inside
- optimal protection by self-adhesive zip covers
- elastic bands at waist, hood, arms and legs provide better, tight closures

Seams: taped seams for additional protection.

dpvlink 25868

Article	Color	Size
2791.100	white / yellow	S-3XL



Disposable suit 5/6 air



Protection in dusty working area. Does not contain any halogen compounds, can thus be disposed without further residues that harm the environment or health.

- high wearing comfort due to lightweight and breathable SMS material
- optimal protection by self-adhesive zip covers
- elastic bands at waist, hood, arms and legs provide better, tight closures

dpvlink 25870

Article	Color	Size
2791.102	white	S-3XL



Disposable suit 5/6 classic



Protection against chemicals in dust and powder form. Does not contain any halogen compounds, can thus be disposed without further residues that harm the environment or health.

- high wearing comfort due to lightweight and breathable material
- skin-friendly non-woven material inside
- optimal protection by self-adhesive zip covers
- elastic bands at waist, hood, arms and legs provide better, tight closures

dpvlink 25872

Article	Color	Size
2791.105	white	S-3XL



Tyvek® Protective clothing ESD

Tyvek® is a special and versatile material. It is durable, but also extremely light and soft. Permeable to air and water vapor, Tyvek® fabric provides an excellent barrier as well against water-based chemicals and aerosols as to particles and fibers. It is low-linting and antistatic. Due to the combination of these special characteristics Tyvek® products are ideal for a wide range of applications and prevent contamination of products and processes by people in the pharmaceutical, food or electronics industry.



Protection: Good barrier to particles due to its structure of extremely fine filaments and a good protection against fine liquid mist and water-based chemicals in low concentration.

Durability: The Tyvek® fabric is extremely durable, tear- and abrasion-resistant. Tyvek® overalls remain intact even under difficult conditions, in case of movements such as those described in the standards for chemical protective clothing.

Comfort: Tyvek® is a breathable fabric. It is permeable to air and water vapor. At the same time it is very soft, light and flexible and feels comfortable on the skin.

Antistatic according to EN 1149-1

Disposable overall Tyvek® 500 Industry Tyvek.



- internal seams
- zip cover
- overall with lapel collar
- elastic cuffs on back, arm and leg ends
- Cat III, type 5 and 6
- certified according to EU 2016/425
- in compliance with EN 14126 and EN 1073-2
- antistatic on both sides according to EN 1149-1

dpmlink 8324

Article	Color	Size	Shipping Unit
2790.201	white	S-XXL	100 piece



Disposable overall Tyvek® 500 Xpert Tyvek.



- external seams
- low inward leakage
- zip cover
- overall with lapel collar
- three-part hood
- elastic cuffs on hood, in the back, on the arm and legs ends
- Cat III, type 5 and 6 B
- certified according to EU 2016/425
- in compliance with EN 14126 and EN 1073-2
- antistatic on both sides according to EN 1149-1

dpmlink 8325

Article	Color	Size	Shipping Unit
2790.205	white	S-3XL	25 piece
2790.206	green	S-XXL	100 piece
2790.207	blue	S-XXL	100 piece



Disposable coat Tyvek® 500 Tyvek.



Material:

Tyvek® 1431 N, 41.5 g/m², antistatic EN 1149-1

Description:

Laboratory coat with lapel collar, 5 snaps, 3 pockets and internal seams

Category:

Cat. III, type PB (6)

dpmlink 8318

Article	Color	Size	Shipping Unit
2790.100	white	M-XXL	10



Disposable coat Tyvek® 500 Tyvek.



Material:

Tyvek® 1431 N, 41.5 g/m², antistatic EN 1149-1

Description:

Laboratory coat with lapel collar, 5 snaps, elastic on the sleeve end, internal seams and without pockets

Category:

Cat. III, type PB (6)

dpmlink 8320

Article	Color	Size	Shipping Unit
2790.105	white	M-XXL	10



Disposable coat Tyvek® 500 Tyvek.



Material:

Tyvek® 1431 N, 41.5 g/m², antistatic EN 1149-1

Description:

Laboratory coat with zipper, lapel collar, 2 pockets and elastic bands on the arm ends

Category:

Cat. III, type PB (6)

dpmlink 8322

Article	Color	Size	Shipping Unit
2790.110	white	S-XXL	10



Disposable cover Tyvek® 500



Material: Tyvek® 1431 N, 41.5 g/m², antistatic EN 1149-1
Description: Hood with large collar, internal seam, elastic bands on face opening and neck
Category: Cat. III, type PB (6)

dpvlink 8337

Article	Color	Shipping Unit
2790.305	white	100



Disposable skirt Tyvek® 500



Material: Tyvek® 1431 N, 41.5 g/m², antistatic EN 1149-1
Description: Skirt with bands in neck and back, length 108 cm
Category: Cat. III, type PB (6)

dpvlink 8339

Article	Color	Shipping Unit
2790.300	white	100



Disposable gauntlets Tyvek® 500



Material: Tyvek® 1431 N, 41.5 g/m², antistatic EN 1149-1
Description: Arm gauntlets with internal seams, 50 cm, adjustable elastic bands on top and bottom of the upper arm (blue)
Category: Cat. III, type PB (6)

dpvlink 8341

Article	Color	Shipping Unit
2790.309	white	200



Disposable overshoe Tyvek® 500



Material: Tyvek® 1431 N, 41.5 g/m², antistatic EN 1149-1.
Description: knee-high overshoe with internal seam, elastic on top and fastening strips (2790.316 with slip-resistant outsole)
Category: Cat. III, type PB (6)

dpvlink 8335

Article	Color	Size	Style	Shipping Unit
2790.315	white	one size	Overshoe	200
2790.316	white	one size	Overshoe / slip-resistant outsole	200



Disposable overshoe Tyvek® 500



Material: Tyvek® 1431 N, 41.5 g/m², antistatic EN 1149-1
Description: overshoe with elastic on the ankle and internal seams
Category: Cat. III, type PB (6)

dpvlink 8330

Article	Color	Size	Shipping Unit
2790.310	white	one size	400



Disposable overshoe Tyvek® 500, slip-resistant



Material: Tyvek® 1431 N, 41.5 g/m², antistatic 1149-1
Description: Overshoe with slip-resistant outsole, elastic on the ankle and internal seams
Category: Cat. III, type PB (6)

dpvlink 8332

Article	Color	suitable for shoe sizes	Shipping Unit
2790.311	white	36-42	200
2790.312	white	42-46	200



Tyvek® is a registered trademark of DuPont or one of its affiliate companies.



ESD

Disposable mask / hygienic mask



Hygienic disposable mask

- with ear band
- 100% polypropylene
- hydrophobic non-woven fabric
- 3 layers
- 12.5 cm metal stripe for optimal fit
- one size fits all
- made in Europe

PU = box with 50 pieces

dpvlink 24453

Article	Style	Color	Size	PU
2795.200	mask	white	one size	50 piece



Disposable mask medical mask type II



Medical disposable mask type II

- 100% polypropylene non-woven fabric
- with meltblown filter layer
- 3 layers
- bacterial filter performance (BFE) ≥ 98%
- metal stripe for optimal fit
- one size fits all
- made in Europe
- complies with the standard EN 14683+AC:2019

PU = box with 50 pieces

dpvlink 24454

Article	Style	Color	Size	PU
2795.200.MM	mask	white	one size	50 piece



Disposable cap / mask



Disposable bouffant cap

- white non-woven
- size 1 = Ø 53 cm
- size 2 = Ø 60 cm

PU = box with 1000 pieces

dpvlink 8435

Article	Style	Color	Size	PU
2795.153	Cover	white	1	1000 piece
2795.160	Cover	white	2	1000 piece



ID card holders

ID card holder Premium



- transparent/clear
- dissipative
- high-quality and flexible material
- insertion pocket with zipper
- upper edging in contrasting yellow
- ESD symbol
- fastening: metal clip

In compliance with the ESD standard DIN EN 61340-5-1

dpvlink 16247

Article	Version	W [mm]	H [mm]
5221.35016	Portrait format	68	107
5221.35017	landscape format	102	86



ID card holder, transparent dissipative



- clear/ transparent
- ESD symbol
- clip closure
- dissipative

In compliance with the ESD standard DIN EN 61340-5-1

dpvlink 398

Article	Version	W [mm]	H [mm]	Thickness [mm]
5221.31.IDP.150	landscape format	95	65	0.15
5221.31.IDP	landscape format	95	65	0.25



ID card holder credit card size



- credit card size
- conductive plastic
- clip closure
- portable in portrait and landscape format

In compliance with the ESD standard DIN EN 61340-5-1

dpvlink 5814

Article	Type
5221.21	Card holder credit card size, black



ESD lanyard



ESD lanyard

- with safety closure
- carabiner
- ESD imprint
- for all ID card holders
- dissipative/yellow

In compliance with the ESD standard DIN EN 61340-5-1



Safety closure (opens when pulling hard)

dpvlink 7884

Article	Type
5221.323	ESD Lanyard



ESD Gloves



ESD gloves are used to dissipate static electricity. This is necessary because susceptible electronics can be damaged or even destroyed by static discharge if the mounting is made without ESD protection.

ESD gloves must fulfill strict requirements with regard to the electrostatic dissipation.

Gloves EPAglove® LEO textile

The gloves of the LEO series are ideal for all dry areas in electronics production. The seamlessly finished textile mixed fabric of the gloves is breathable and combines a perfect fit with a comfortable wearing. Due to the knitted antistatic agent the gloves of type LEO have very good dissipation values. The antistatic agent is not resistant to water and cleanser.

ESD gloves LEO 100 / 200



Gloves made of textile mixed fabric, not washable, very good dissipation values, seamlessly finished, perfect fit, comfortable to wear, nickel-free.

In compliance with the ESD standard DIN EN 61340-5-1 

Available sizes: S, M, L, XL, XXL (model LEO 200 also available in XS)



dpvlink 8343

Article	Type	Size	Color
2070.3100	ESD glove LEO 100	S-XXL	white
2070.3200	ESD glove LEO 200	XS-XXL	grey
2070.3100.SET	ESD glove LEO 100, set mixed sizes S-XXL		white
2070.3200.SET	ESD glove LEO 200, set mixed sizes XS-XXL		grey



ESD gloves LEO 105 / 205



Gloves made of textile mixed fabric, not washable, very good dissipation values due to knitted antistatic agents, seamlessly finished, perfect fit, comfortable to wear, nickel-free.

- PU-coated fingertips

In compliance with the ESD standard DIN EN 61340-5-1 

Available sizes: XS, S, M, L, XL, XXL



dpvlink 8404

Article	Type	Size	Color
2070.3105	ESD glove LEO 105	XS-XXL	white
2070.3205	ESD glove LEO 205	XS-XXL	grey
2070.3105.SET	ESD glove LEO 105, set mixed sizes XS-XXL		white
2070.3205.SET	ESD glove LEO 205, set mixed sizes XS-XXL		grey



ESD gloves LEO 110 / 210



Gloves made of textile mixed fabric, not washable, very good dissipation values due to knitted antistatic agent, seamlessly finished, perfect fit, comfortable to wear, nickel-free.

- PU-coated palm and fingertips

In compliance with the ESD standard DIN EN 61340-5-1 

Available sizes: S, M, L, XL, XXL (model LEO 210 also available in XS)



dpvlink 8406

Article	Type	Size	Color
2070.3110	ESD glove LEO 110	S-XXL	white
2070.3210	ESD glove LEO 210	XS-XXL	grey
2070.3110.SET	ESD glove LEO 110, set mixed sizes S-XXL		white
2070.3210.SET	ESD glove LEO 210, set mixed sizes XS-XXL		grey



ESD gloves LEO 125 PLUS



Flexible gloves of very fine nylon fabric, not washable, very high dissipation values due to knitted antistatic agent, seamlessly processed, perfect fit, comfortable to wear, nickel-free, with coated PU fingertips.

In compliance with the ESD standard DIN EN 61340-5-1

available sizes: XS, S, M, L, XL, XXL



dpvlink 17858

Article	Type	Size	Color
2070.3125	ESD glove LEO 125+	XS-XXL	white
2070.3125.SET	ESD glove LEO 125+, set mixed sizes XS-XXL		white

ESD gloves LEO 130 PLUS



Flexible gloves of very fine nylon fabric, not washable, very high dissipation values due to knitted antistatic agent, seamlessly processed, perfect fit, comfortable to wear, nickel-free, PU coated palm and fingertips.

In compliance with the ESD standard DIN EN 61340-5-1

available sizes: XS, S, M, L, XL, XXL



dpvlink 17864

Article	Type	Size	Color
2070.3130	ESD glove LEO 130+	XS-XXL	white
2070.3130.SET	ESD glove LEO 130+, set mixed sizes XS-XXL		white

Gloves EPAglove® CARBON textile

ESD glove Carbon 200 STANDARD



Gloves made of textile mixed fabric with carbon fiber, breathable, dissipative, seamlessly finished, perfect fit, comfortable to wear, nickel-free.

In compliance with the ESD standard DIN EN 61340-5-1

Available sizes: S, M, L, XL, XXL



dpvlink 16324

Article	Type	Size	Conductive fiber
2070.4200	ESD glove Carbon 200 STANDARD	S-XXL	Carbon
2070.4200.SET	ESD glove Carbon 200 STANDARD, set mixed sizes XS-XXL		Carbon

ESD glove Carbon 205 AMPERE



Gloves made of mixed textile fabric with carbon fibers, breathable, dissipative, seamlessly finished, perfect fit, comfortable to wear, nickel-free.

- PU-coated fingertips

In compliance with the ESD standard DIN EN 61340-5-1

Available sizes: XS, S, M, L, XL, XXL



dpvlink 16325

Article	Type	Size	Conductive fiber
2070.4205	ESD glove Carbon 205 AMPERE	XS-XXL	Carbon
2070.4205.SET	ESD glove Carbon 205 AMPERE, set mixed sizes XS-XXL		Carbon

ESD glove Carbon 210 VOLT



Gloves made of textile mixed fabric (75% nylon, 25% carbon), breathable back of the hand, dissipative, seamlessly finished, perfect fit, comfortable to wear, nickel-free.

- PU-coated palm and fingertips

In compliance with the ESD standard DIN EN 61340-5-1 

Available sizes: XS, S, M, L, XL, XXL



ESD glove Copper 105 AMPERE



Gloves made of textile mixed fabric with copper fibers, breathable, dissipative, seamlessly finished, perfect fit, comfortable to wear, nickel-free.

- PU-coated fingertips

In compliance with the ESD standard DIN EN 61340-5-1 

Available sizes: S, M, L, XL, XXL



dpvlink 19486

Article	Type	Size	Conductive fiber	
2070.4210	ESD glove Carbon 210 VOLT	XS-XXL	Carbon	
2070.4210.SET	ESD glove Carbon 210 VOLT, set mixed sizes XS-XXL		Carbon	

dpvlink 415

Article	Type	Size	Conductive fiber	
2070.4105	ESD glove Copper 105 AMPERE	S-XXL	Copper	
2070.4105.SET	ESD glove Copper 105 AMPERE, set mixed sizes S-XXL		Copper	

Gloves EPAglove® COPPER textile

The gloves COPPER made of textile mixed fabric with woven conductive copper fibers offer a very good, durable dissipation. All gloves are seamlessly finished and combine perfect fit with comfortable wearing.

In compliance with the ESD standard DIN EN 61340-5-1 

ESD glove Copper 100 STANDARD



Gloves made of textile mixed fabric with copper fibers, breathable, dissipative, seamlessly finished, perfect fit, comfortable to wear, nickel-free.

In compliance with the ESD standard DIN EN 61340-5-1 

Available sizes: S, M, L, XL, XXL



ESD glove Copper 110 VOLT



Gloves made of textile mixed fabric with copper fibers, breathable, dissipative, seamlessly finished, perfect fit, comfortable to wear, nickel-free.

- PU coated palm and fingertips

In compliance with the ESD standard DIN EN 61340-5-1 

Available sizes: S, M, L, XL, XXL



dpvlink 411

Article	Type	Size	Conductive fiber	
2070.3355	ESD glove Copper 100 STANDARD	S-XXL	Copper	
2070.3355.SET	ESD glove Copper 100 STANDARD, set mixed sizes S-XXL		Copper	

dpvlink 417

Article	Type	Size	Conductive fiber	
2070.4110	ESD glove Copper 110 VOLT	S-XXL	Copper	
2070.4110.SET	ESD glove Copper 110 VOLT, set mixed sizes S-XXL		Copper	

ESD glove Copper 115 MICRODOTS



Gloves made of textile mixed fabric with copper fibers, breathable, dissipative, seamlessly finished, perfect fit, comfortable to wear, nickel-free.

- palm with PVC micro dots

In compliance with the ESD standard DIN EN 61340-5-1 ⚠

Available sizes: S, M, L, XL, XXL



dpvlink 413

Article	Type	Size	Conductive fiber
2070.4115	ESD glove Copper 115 MICRODOTS	S-XXL	Copper
2070.4115.SET	ESD glove Copper 115 MICRODOTS, set mixed sizes S-XXL		Copper



Gloves polyester



The gloves made of polyester with woven, conductive carbon fibers have good dissipation values and are suitable for the use in cleanrooms.

ESD glove YUKO



ESD gloves YUKO made of polyester with conductive carbon fiber

- lint-free
- dissipative

In compliance with the ESD standard DIN EN 61340-5-1 ⚠

Available sizes: S, M, L, XL



dpvlink 425

Article	Type	Size
2071.5201	ESD glove YUKO Eco	S-XL
2071.5201.SET	ESD glove YUKO Eco, set mixed sizes S-XL	



ESD glove MEGUMI



ESD gloves MEGUMI made of polyester with conductive carbon fiber

- PU-coated palm (antistatic)
- lint-free
- dissipative

In compliance with the ESD standard DIN EN 61340-5-1 ⚠

Available sizes: S, M, L, XL



dpvlink 22641

Article	Type	Size
2071.5234	ESD glove MEGUMI Eco	S-XL



ESD glove MIKA



ESD gloves MIKA made of polyester with conductive carbon fiber

- lint-free
- dissipative
- palm with plastic dots (antistatic)

In compliance with the ESD standard DIN EN 61340-5-1 

Available sizes: S, M, L, XL



dpvlink 421

Article	Type	Size	
2071.5241	ESD glove MIKA Eco	S-XL	
2071.5242	ESD glove MIKA Eco II with cuffs	S-XL	
2071.5241.SET	ESD glove MIKA Eco, set mixed sizes S-XXL		
2071.5242.SET	ESD glove MIKA Eco II avec cuffs, set mixed sizes S-XXL		

Gloves TEGERA

Glove TEGERA 30



Glove TEGERA 30 made of goatskin with nylon back

- high-quality materials
- reinforced index finger
- better fit due to elastic band

Available sizes: 5, 6, 7, 8, 9, 10, 11

In compliance with the standard DIN EN-61340-2-3



dpvlink 12925

Article	Type	Size	Color	
2070.TEGERA30	Glove TEGERA 30	5-11	blue / white	

Glove TEGERA 9101



Glove TEGERA 9101 made of Microthan/nylon/carbon fiber

- high-quality materials
- dissipative
- chrome- nickel- and silicone-free
- better fit due to elastic band

Available sizes: 5, 6, 7, 8, 9, 10

In compliance with the standard DIN EN 61340-2-3



dpvlink 12927

Article	Type	Size	Color	
2070.TEGERA9101	Glove TEGERA 9101	5-10	black / white	

ESD glove TEGERA 800



Thin ESD glove TEGERA 800 made of carbon fibers, polyester.

- good fitting
- breathable
- nickel-free
- good sensitivity of the fingertips

In compliance with the ESD standard DIN EN 61340-5-1 

Available sizes: 5, 6, 7, 8, 9, 10, 11, 12



dpvlink 26028

Article	Type	Size	Color	
2070.TEGERA800	ESD glove TEGERA 800	5-12	grey	

ESD glove TEGERA 801



Thin ESD glove TEGERA 801 made of carbon fibers, polyester, polyurethane.

- good fitting
- breathable
- nickel-free
- good sensitivity of the fingertips
- PU-coated fingertips

In compliance with the ESD standard DIN EN 61340-5-1

Available sizes: 5, 6, 7, 8, 9, 10, 11, 12



dpvlink 26030

Article	Type	Size	Color
2070.TEGERA801	ESD glove TEGERA 801	5-12	grey / white



ESD glove TEGERA 802



Thin ESD glove TEGERA 802 made of carbon fibers, polyester, polyurethane.

- good fitting
- breathable
- nickel-free
- good sensitivity of the fingertips
- PU-coated fingertips

In compliance with the ESD standard DIN EN 61340-5-1

Available sizes: 5, 6, 7, 8, 9, 10, 11, 12



dpvlink 26032

Article	Type	Size	Color
2070.TEGERA802	ESD glove TEGERA 802	5-12	grey / white



ESD glove TEGERA 803



Thin ESD cut protection glove TEGERA 803 made of polyethylene, carbon fibers, glass fiber filaments, polyester, elastane.

- PU-coated palm
- cut protection glove class B EN 388:2016
- suitable for touchscreen
- breathable
- good sensitivity of the fingertips
- good fitting
- suitable for dry and clean areas

In compliance with the ESD standard DIN EN 61340-5-1

Available sizes: 5, 6, 7, 8, 9, 10, 11, 12



dpvlink 25756

Article	Type	Size	Color
2070.TEGERA803	ESD cut protection glove TEGERA 8035-12		black / blue



ESD glove TEGERA 804



Thin ESD cut protection glove TEGERA 804 made of polyethylene, carbon fibers, glass fiber filaments, polyester, elastane.

- PU-coated palm
- cut protection glove class C EN 388:2016
- suitable for touchscreen
- good sensitivity of the fingertips
- resistant to oils, greases
- latex- and nickel-free
- heat-resistant up to 100°C

In compliance with the ESD standard DIN EN 61340-5-1

Available sizes: 5, 6, 7, 8, 9, 10, 11, 12



dpvlink 25758

Article	Type	Size	Color
2070.TEGERA804	ESD cut protection glove TEGERA 8046-11		black / grey



ESD glove TEGERA 805

ESD glove TEGERA 805 made of 90% nylon, 10% carbon fibers

- breathable
- high-quality materials
- comfortable
- nickel-free
- suitable for dry and clean areas

In compliance with the ESD standard DIN EN 61340-5-1 

Available sizes: 6, 7, 8, 9, 10,11



[dpvlink 19593](#)

Article	Type	Size	Color
2070.TEGERA805	ESD glove TEGERA 805	6-11	grey



ESD glove TEGERA 810

ESD glove TEGERA 810 made of 80% nylon, 10% polyurethane, 10% carbon fibers

- PU-coated fingertips
- high-quality materials
- suitable for the use in dry areas and cleanrooms
- smooth surface

In compliance with the ESD standard DIN EN 61340-5-1 

Available sizes: 5, 6, 7, 8, 9, 10,11



[dpvlink 19591](#)

Article	Type	Size	Color
2070.TEGERA810	ESD glove TEGERA 810	5-11	grey



ESD glove TEGERA 806

Thin ESD cut protection glove TEGERA 806 made of polyethylene, carbon fibers, glass fiber filaments, polyester, elastane.

- cut protection class C EN 388:2016
- breathable
- very good sensitivity of the fingertips
- good fitting
- latex- and nickel-free
- suitable for dry and clean areas

In compliance with the ESD standard DIN EN 61340-5-1 

Available sizes: 5, 6, 7, 8, 9, 10, 11, 12



[dpvlink 25754](#)

Article	Type	Size	Color
2070.TEGERA806	ESD cut protection glove TEGERA 806 6-12		grey / blue



ESD glove TEGERA 811

ESD glove TEGERA 811 made of 60% nylon, 30%, polyurethane, 10% carbon fibers

- PU-coated palm
- comfortable
- robust
- nickel-free
- suitable for dry areas and cleanroom
- smooth surface

In compliance with the ESD standard DIN EN 61340-5-1 

Available sizes: 6, 7, 8, 9, 10



[dpvlink 19589](#)

Article	Type	Size	Color
2070.TEGERA811	ESD glove TEGERA 811	6-10	grey / white



ESD glove TEGERA 879



Ultra-thin ESD glove TEGERA 879 made of nitrile foam, carbon fibers, nylon, elastane.

- Nitrile-coated palm
- foam grip pattern
- latex- and nickel-free
- suitable for touchscreen
- breathable
- good sensitivity of the fingertips
- good fitting
- suitable for dry and clean areas

In compliance with the ESD standard DIN EN 61340-5-1 ⚠

Available sizes: 5, 6, 7, 8, 9, 10, 11, 12



dpvlink 25760

Article	Type	Size	Color
2070.TEGERA879	ESD glove TEGERA 879	6-12	black / grey



ESD glove TEGERA 877



Very thin ESD glove TEGERA 877 made of polyethylene, carbon fibers, nylon.

- PU-coated palm
- smooth surface
- suitable for touchscreen
- breathable
- nickel-free
- very good sensitivity of the fingertips
- good fitting
- suitable for dry and clean areas

In compliance with the ESD standard DIN EN 61340-5-1 ⚠

Available sizes: 5, 6, 7, 8, 9, 10, 11, 12



dpvlink 25764

Article	Type	Size	Color
2070.TEGERA877	ESD glove TEGERA 877	5-12	black / blue



ESD glove TEGERA 878



Very thin ESD glove TEGERA 878 made of nylon.

- PU-coated palm
- smooth surface
- breathable
- nickel-free
- good sensitivity of the fingertips
- very good fitting
- suitable for dry and clean areas

In compliance with the ESD standard DIN EN 61340-5-1 ⚠

Available sizes: 5, 6, 7, 8, 9, 10, 11, 12



dpvlink 25762

Article	Type	Size	Color
2070.TEGERA878	ESD glove TEGERA 878	5-12	white



Uvex gloves

Glove phynomic airLite A 

Glove phynomic airLite A made of polyamid, elastane and carbon

- ergonomic fitting
- palm with carbon coating
- fingertips with Aqua polymer coating
- very flexible
- very good tactile touch
- very breathable
- suitable for touchscreen

In compliance with the ESD standard DIN EN 61340-5-1 

Available sizes: 5, 6, 7, 8, 9, 10, 11, 12



dpvlink 27081

Article	Type	Size	Color
UX-60038	Glove phynomic airLite A	5-12	black



Cut protection glove phynomic airLite B 

Cut protection glove phynomic airLite B made of Dyneema* Diamond 2.0 fibers, polyamid, elastane and carbon

- ergonomic fitting
- palm with carbon coating
- fingertips with Aqua polymer coating
- good grip
- very good tactile touch
- very breathable
- suitable for touchscreen
- cut protection class B EN 388:2016

In compliance with the ESD standard DIN EN 61340-5-1 

Available sizes: 5, 6, 7, 8, 9, 10, 11, 12



dpvlink 27083

Article	Type	Size	Color
UX-60078	Cut protection glove phynomic airLite B	6-12	grey / black



Cut protection glove phynomic airLite C 

Cut protection glove phynomic airLite C made of Dyneema* Diamond 2.0 fibers, polyamid, elastane and carbon

- ergonomic fitting
- palm with carbon coating
- fingertips with Aqua polymer coating
- good grip
- very good tactile touch
- very breathable
- suitable for touchscreen
- cut protection class C EN 388:2016

In compliance with the ESD standard DIN EN 61340-5-1 

Available sizes: 5, 6, 7, 8, 9, 10, 11, 12



dpvlink 27085

Article	Type	Size	Color
UX-60084	Cut protection glove phynomic airLite C	6-12	blue / black



Glove athletic lite 

Glove athletic lite made of polyamid, elastane and carbon

- good grip
- palm with elastane coating
- fingertips with NBR foam coating
- very flexible
- very good tactile touch
- suitable for touchscreen

In compliance with the ESD standard DIN EN 61340-5-1 

Available sizes: 6, 7, 8, 9, 10, 11



dpvlink 27087

Article	Type	Size	Color
UX-60035	Glove athletic lite	6-11	blue / black



Disposable gloves

Disposable nitrile gloves ESD



- antistatic
- powder-free and silicone-free
- textured gripping surface
- 100% nitrile
- without plasticizer
- available sizes: S (7), M (8), L (9), XL (10)

In compliance with the ESD standards DIN EN 61340-2-3, IEC 61340-5-1, IEC 61340-5-2

Advantages:

- Prevents latex allergies (type I)
- High protection against penetrating chemicals and chemical splashes
- Chlorinated glove for more comfort and grip as well as reduced bonding
- Wearing comfort like a second skin, more pleasant texture and easy to put on
- Low Modulus for a pleasant fit and lower fatigue
- Structured surface of the fingertips for a better grip

dpvlink 23094

Article	Size	L [mm]	Thickness [mm]	PU	Packing
2750.7550	S-XL	240	0,10		100 piececarton

Disposable PVC glove ESD



Disposable ESD glove of 100% PVC

- antistatic
- non-powdered
- chemical-resistant
- latex-free
- suitable for touchscreen
- thickness 0.08 or 0.10 mm

In compliance with the ESD standard DIN EN 61340-5-1

Available sizes: 7, 8, 9, 10,11



dpvlink 25766

Article	Size	L [mm]	Thickness [mm]	PU	Packing
2070.TEGERA819A	7-11	240	0.08		100 piececarton
2070.TEGERA825A	7-11	240	0,10		100 piececarton

Disposable vinyl gloves ESD



- antistatic
- long design
- suitable for ISO 5
- PU = 1.000 pcs per box
- Available sizes: S, M, L, XL

In compliance with the ESD standard 61340-5-1

dpvlink 427

Article	Type	Size
2750.000	Vinyl glove	S-XL

Underneath half-finger glove



- light nylon fabric
- suitable for wearing underneath vinyl gloves
- unlimited sensitivity of the fingertips
- one size fits all

dpvlink 429

Article	Type	Size
2071.9913	Underneath half-finger glove	One size fits all

Finger cots

Finger cots, antistatic



Finger cots are important when handling sensitive components. They assure the protection of the products against static discharge and avoid finger prints.

In compliance with the ESD standard DIN EN 61340-5-1
PU = 1440 pcs

dpvlink 435

Article	Type	Size	Color
2750.100	Finger cots latex	S-XL	rose
2750.105	Finger cots nitrile	S-XL	white
2750.101	Finger cots latex with textured fingertips	S-XL	rose

Finger cots, conductive



Finger cots are important when handling sensitive components. They assure the protection of the products against static discharge and avoid finger prints.

conductive PU = 1440 pcs.

dpvlink 433

Article	Type	Material	Size	Color
2750.110	Finger cots	natural rubber latex	S-XL	black

ESD Swivel chairs EPAchair®



EPAchair® ESD work swivel chairs assure ergonomics and ESD safety at the workstation. A careful material selection of materials and components ensures **high quality**. A selection of different upholstery materials and colors allows for an optimal integration of the EPAchair models into diverse working environments. You can choose between different models, starting from the climbing aid to the ergonomic work swivel chair. All models of the EPAchair® series are **ESD-compliant according to DIN EN 61340-5-1** 



All models of the der EPAchair® ESD work swivel chairs are produced in Germany



Highlights EPAchair® swivel chairs

1. Adjustable seat tilt
2. Different ESD upholstery covers
 - ESD Dralon fabric
 - ESD SKAI synthetic leather
 - conductive PU solid material
3. Adjustable seat depth
4. Dissipative seat shell
5. Made in Germany
6. Weight up to 130 kg
7. Dissipative safety double castors or glides
8. ESD-compliant according to DIN EN 61340-5-1 
9. Adjustable seat height
10. Multifunctional armrest (optional)
11. Dissipative back shell

Information about the ESD swivel chairs EPAchair® is clearly summarized in the current leaflet available



- as online catalog
- as download
- as printed version (only German)



Fabric dralon® ESD

available in:

- black
- anthracite
- blue
- medium blue

Advantages

- soft and comfortable
- breathable
- washable

Synthetic leather skai® ESD

available in:

- black

Advantages

- soft and comfortable
- washable
- insensitive to oil
- hard-wearing

All upholstery types comply with the ESD standard DIN EN 61340-5-1 



ESD-safe

In compliance with the ESD standard DIN EN 61340-5-1



Seat height adjustable

with gas spring up to 83 cm depending on model



Seat depth adjustable



Seat tilt adjustable

promotes ergonomic posture



Backrest height adjustable

Backrest height adjustable according to the body height



Permanent contact backrest

allows for a permanent contact between backrest and back



Weight control

Individual adjustment of the counter-pressure of the backrest to the body weight



Asynchronous mechanism

Tilt angles of backrest and seat surface can be adapted independently



Upholstery dralon® ESD

available with cover of conductive fabric dralon® ESD (DIN EN 61340-5-1)



Upholstery synthetic leather skai® ESD

available with cover of conductive synthetic leather skai® ESD (DIN EN 61340-5-1)



Upholstery of polyurethane ESD

Conductive upholstery of polyurethane ESD (DIN EN 61340-5-1)



Made in Germany

All EPAchair® ESD swivel chairs are produced in Germany

EPChair® - Modellübersicht



	ESD-Drehstuhl Classic Economy	ESD-Drehstuhl Classic Ergonomic	ESD-Drehstuhl Classic Comfort	ESD-Drehstuhl Comfort 5000	ESD-Drehstuhl PU 1400	ESD-Drehstuhl PU 1405 / 1410
Sitz: höhenverstellbar	Stufenlos 43 - 55 cm	Stufenlos 43 - 55 cm	Stufenlos 43 - 55 cm 46 - 59 cm (Comfort-plus) 57 - 83 cm (Hochstuhl)	Stufenlos 46 - 59 cm	Stufenlos 41 - 54 cm	Stufenlos 43 - 56 cm 57 - 83 cm (Hochstuhl)
Sitz: tiefenverstellbar	-	-	✓ Nur Comfort-plus 023.2604	✓	-	-
Sitz: neigeverstellbar	-	✓	✓	✓	-	✓
Sitz: Größe Sitzfläche	46 x 44 cm	47 x 44 cm	47 x 44 cm 50 x 45 cm (Comfort-Plus)	50 x 45 cm	43 x 40 cm	46 x 40 cm
Lehne: höhenverstellbar	✓ Stufenlos	✓ Stufenweise	✓ Stufenweise	✓ Stufenweise	✓ Stufenweise	✓ Stufenweise
Lehne: neigeverstellbar	✓	✓	✓	✓	✓	✓
Lehne: Rückenlehnenhöhe	ca. 40 cm	ca. 40 cm ca. 50 cm	ca. 40 cm ca. 50 cm	ca. 55 cm	ca. 32 cm	ca. 29 cm
Asynchrontechnik	-	✓	✓	✓	-	✓
Permanentkontaktrückenlehne	-	✓	✓	✓	-	✓
Gewichtsregulierung: einstellbarer Rückenlehnen-Gegendruck	-	✓	✓	✓	-	✓
Poliertes Aluminium-Fußkreuz	✓	✓	✓	✓	✓	✓
ESD-Schutz: leitfähige Polsterung	✓	✓	✓	✓	✓ PU	✓ PU
ESD-Schutz: ableitfähige Rollen/ Gleiter	✓	✓	✓	✓	✓	✓
ESD-Schutz: ableitfähiger Rücken / Rückenaussenschale	✓	✓	✓	✓	✓	✓
ESD-Schutz: ableitfähiger Sitz / Sitzaussenschale	✓	✓	✓	✓	✓	✓

	ESD-Stehhilfe PU Fusskreuz	ESD-Stehhilfe PU Fussteller	ESD-Drehhocker 1300 / 1301 / 1320	ESD-Drehhocker PU 1390 / 1392	ESD-Sattelhocker 1350	
Sitz: höhenverstellbar	Stufenlos 57 - 83 cm	Stufenlos 57 - 83 cm	Stufenlos 43 - 56 cm 57 - 83 cm (Hochhocker)	Stufenlos 43 - 56 cm 57 - 83 cm (Hochhocker)	Stufenlos 44 - 57 cm	
Sitz: neigeverstellbar	✓ Nur Comfort 023.1505.PU-ESD stufenlos 20°	✓ Nur Comfort 023.1505.PU-ESD stufenlos 20°	✓ Nur 1301 Ergo 023.1301 3D-Wippfunktion bis zu 12°	-	-	
Sitz: Größe Sitzfläche	35 x 24 cm	35 x 24 cm	Ø 40 cm	Ø 32 cm	40 x 42 cm	
Poliertes Aluminium-Fußkreuz	✓	Fußsteller	✓	✓	✓	
ESD-Schutz: leitfähige Polsterung	✓ PU	✓ PU	✓	✓ PU	✓	
ESD-Schutz: ableitfähige Rollen/ Gleiter	✓	Verchromter Fußsteller	✓	✓	✓	

ESD Swivel chair Comfort 5000



- Stepless seat height adjustment by safety gas spring, seat height approx. 46 -59 cm
- **Seat adjustable in tilt and depth**
- Seat surface 50 x 45 cm
- Backrest adjustable in height (steplessly) and tilt
- Backrest height approx. 55 cm
- Individual asynchronous adjustment of seat and backrest
- Permanent contact backrest
- Weight regulation adjustable with rotary knob
- Polished aluminum base
- In compliance with the ESD standard DIN EN 61340-5-1 
 - conductive upholstery
 - dissipative safety double castors
 - **dissipative back shell**
 - **dissipative seat shell**

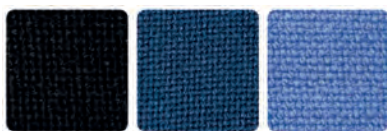

Stoff schwarz .100-ESD Stoff blau .220-ESD Stoff mittelblau .225-ESD



dpvlink 20722

Article	Type
023.5000	ESD Swivel chair Comfort 5000



Accessories Comfort 5000



dpvlink 20933

Article	Description
023.2474-ESD	Multifunction armrest ESD for swivel chair Comfort 5000 Plastic black (set = 2 pieces)



ESD Swivel chair CLASSIC Ergonomic



- **Ergonomically shaped, disk-friendly seat surface**
- Stepless seat height adjustment by safety gas spring, seat height approx. 43 -55 cm
- Seat adjustable in tilt
- Seat surface 47 x 44 cm
- Backrest adjustable in height (stepwise) and tilt
- Backrest height approx. 40 cm / 50 cm
- Individual asynchronous adjustment of seat and backrest
- Permanent contact backrest
- Weight regulation adjustable with rotary knob
- Polished aluminum base
- In compliance with the ESD standard DIN EN 61340-5-1 
 - conductive upholstery
 - dissipative safety double castors
 - **dissipative back shell**
 - **dissipative seat shell**



Stoff schwarz .100-ESD Stoff anthrazit .110-ESD Stoff blau .220-ESD Kunstleder schwarz .330-ESD



dpvlink 14582

Article	Type
023.2700	ESD Swivel chair CLASSIC Ergonomic backrest approx. 40 cm
023.2703	ESD Swivel chair CLASSIC Ergonomic backrest approx. 50 cm



Accessories CLASSIC Ergonomic



dpvlink 20932

Article	Description
023.2461-ESD	Multifunction armrest ESD for swivel chair CLASSIC Ergonomic plastic black (set = 2 pieces)



Systems against Electrostatics

ESD Swivel chair CLASSIC Comfort



- Stepless seat height adjustment by safety gas spring, seat height approx. 43 -55 cm / 57 - 83 cm
- Seat adjustable in tilt
- Seat surface 57 x 44 cm
- Version Comfort-plus with adjustable seat depth and larger seat surface 50 x 45 cm
- Backrest adjustable in height (steplessly) and tilt
- Backrest height approx. 40 cm / 50 cm
- Individual asynchronous adjustment of seat and backrest
- Permanent contact backrest
- Weight regulation adjustable with rotary knob
- Polished aluminum base
- In compliance with the ESD standard DIN EN 61340-5-1 ⚡
 - conductive upholstery
 - dissipative safety double castors
 - **dissipative back shell**
 - **dissipative seat shell**

Model Comfort-plus with seat depth adjustment and larger seat surface



Stoff schwarz .100-ESD Stoff anthrazit .110-ESD Stoff blau .220-ESD Kunstleder schwarz .330-ESD



dpvlink 14583

Article Type



023.2600 **ESD Swivel chair CLASSIC Comfort**
 Seat height: 43-55 cm
 Backrest height approx. 40 cm
 dissipative safety double castors for hard surfaces

dpvlink 14583

Article Type



023.2603 **ESD Swivel chair CLASSIC Comfort**
 Seat height: approx. 43 - 55 cm
 Backrest height approx. 50cm
 dissipative safety double castors for hard surfaces



023.2604 **ESD Swivel chair CLASSIC Comfort-plus**
 Seat height: approx. 46 - 59 cm
 Seat surface 50 x 45 cm
 Backrest height approx. 50 cm
 seat depth adjustment
 dissipative safety double castors for hard surfaces



023.2620 **ESD Swivel chair CLASSIC Comfort**
 High chair with seat height: approx. 57-83 cm
 Backrest approx. 40 cm
 Height-adjustable foot ring
 dissipative glides

Accessories series CLASSIC



dpvlink 14896

Article



023.2463-ESD **Multifunctional armrest ESD**
 for swivel chair CLASSIC Comfort-plus
 plastic black (set = 2 pieces)



023.2490-ESD **ESD castors soft for hard floors**
 Set = 5 pieces



023.2495-ESD **ESD castors hard for soft floors**
 Set = 5 pieces



023.2499-ESD **ESD glides**
 Set = 5 pieces



023.2480 **Extended gas spring (extra charge)**
 Extension
 seat height 51-68 cm with series Classic
 seat height 55-73 cm with Classic Comfort-plus and DPV Comfort 5000
 lift approx. 200 mm

ESD Swivel chair CLASSIC Economy



- Stepless seat height adjustment by safety gas spring, seat height approx. 43 -55 cm
- Seat surface 46 x 44 cm
- Backrest adjustable in height (stepless) and tilt
- Backrest height approx. 40 cm
- Polished aluminum base
- In compliance with the ESD standard DIN EN 61340-5-1 
 - conductive upholstery
 - dissipative safety double castors
 - **dissipative back shell**
 - **dissipative seat shell**

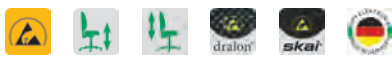

dpvlink 14581

Article	Type
023.2500	ESD Swivel chair CLASSIC Economy dissipative safety double castors for hard surfaces



ESD swivel stools

ESD swivel stool 1300 / 1320



EPA chair



ESD swivel stool with **durable ESD upholstery** and good seating comfort for nearly every application.

- Stepless seat height adjustment by safety gas spring, seat height approx. 43-56 cm / 57-83 cm
- Seat surface Ø 40 cm
- Polished aluminum base
- In compliance with the ESD standard DIN EN 61340-5-1 
 - conductive PU upholstery
 - dissipative castors/glides



dpvlink 20751

Article	Type
023.1300	ESD swivel stool 1300 seat height 43-56 cm dissipative safety double castors for hard floors
023.1320	ESD swivel stool 1320 with foot ring seat height 57-83 cm dissipative glides height-adjustable footring



ESD Swivel stool 1301 Ergo



ESD swivel stool with **durable ESD upholstery** and innovative seat mechanism that adapt automatically to every posture and provides healthy ergonomics.

- spring-loaded 3D rocking function for healthy and ergonomic sitting (tilt up to 12°)
- 3D rocking function ensures permanent movement and encourages active sitting
- stepless seat height adjustment by safety gas spring
seat height approx. 43 - 56 cm
- seat surface Ø 40 cm
- polished aluminum base
- in compliance with the ESD standard DIN EN 61340-5-1 ⚠️
 - conductive upholstery
 - dissipative castors



Stoff schwarz .100-ESD Stoff blau .220-ESD Kunstleder schwarz .330-ESD

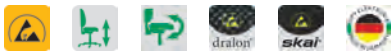

dpvlink 23862

Article Type



023.1301 **ESD Swivel stool 1301 Ergo**
Seat height 43-56 cm
dissipative safety double castors for hard floors

bimos



Bimos Neon

Outstanding design quality meets excellent ergonomics and exceptional comfort - Neon is the new generation work chair in production. No other work chair has comparable features.

Thanks to its innovative 1+1 system, the upholstery of the work chair can be changed with just one click. In this way, the Neon work chair ensures flexibility, sustainability and perfect visual adaptation to the respective workplace.



red dot design award



German Design Award

WINNER 2013

The Advantages of **Bimos Neon** at a Glance:

- 10-year warranty
- Individually configurable
- Modular design
- Ultimate adjustment options
- Outstanding ergonomics
- Excellent design
- Innovative functions
- ESD-compliant



Configure now in the online shop

Measurement and test equipment

EPApr[®] Personnel Tester 1000



The innovative EPApr[®] end-to-end solution for your ESD protected working areas combines a user-friendly precision hardware with a forward-looking software solution designed for the measurement

of your ESD safety equipment as well as the comfortable and standard-compliant documentation and central management of the collected data. Multifunctional EPApr[®] interfaces and switch outputs allow for a simple integration in the existing infrastructure of your company.



The advantages of the EPApr[®] personnel grounding control system:

- Quick measurement, extensive measuring options with short test time
 - User-friendly, simple handling
 - Standard-compliant testing in compliance with DIN EN 61340-5-1 and ANSI ESD S20.20
 - Intuitive user interface with clear display of the results
 - Suitable for the use in access control systems
 - Simple, menu-driven calibration on-site
 - Adjustable measuring voltage and configurable thresholds
 - Compliant with all usual standards
 - Data logging in compliance with GDPR
 - Suitable for cross-location networking via LAN or WLAN
 - Simple data handling and secure archiving on a central server
 - Vast report functions
- 
- Simple backup functions allow retrieving backup files with Single Click at any time
 - Automated data exchange with other programs
 - No client software required, server installation via VM (Virtual Machine)
 - Simple update function and maintenance via the EPApr[®] portal



Further information

about the EPApr[®] Personnel Tester 1000 and the EPApr[®] Control Server software is available in the detailed leaflet and online on our web site.

EPApr[®] Personnel Tester 1000



The EPApr[®] 1000 is a compact measuring device to verify the personnel grounding and fulfills the requirements of DIN EN ISO 61340-5-1, ANSI ESD S20.20 and GDPR (general data protection regulation). Programmable switch outputs allow using it as access control. A privacy mode offers the possibility to log and display the measurement without names. The measurements are logged and stored in the EPApr[®] 1000 device conforming to standards and the GDPR. It is possible to retrieve measured data via network or maintain them locally on the device by means of the stand-alone function.



EPApr[®] 1000 at a glance

- Simultaneous measurement of shoes and wriststraps with short test time < 2 seconds
- Comfortable guest function e.g. for changing visitors
- Measurement of single shoe or in series as well as hands-free mode
- Adjustable measuring voltage with individual voltage reduction for sensitive persons
- Configurable thresholds
- Suitable for personnel access control systems
- Person identification with integrated Multi RFID reader
- Compliant with all usual standards, existent ID cards can still be used
- Documentation of the measured values
- Access release / barrier controllable via configurable switch outputs
- Intuitive user interface with clear display of the results
- Privacy mode: display mode without showing personal data
- Password-protected access for administrators and managers
- Standard-compliant testing in compliance with DIN EN 61340-5-1 and ANSI ESD S20.20
- Data logging in compliance with GDPR
- Menu-driven calibration mode for simple calibration on site (returning the device for calibration is not necessary)
- Connectable via LAN or optionally WLAN adapter
- Languages German and English (GB)
- **Made in Germany**

Recommendation: Interconnection with EPApr[®] Control Server



The EPApr[®] 1000 device can be connected as a single device (Stand Alone) or via the company network with the optionally available EPApr[®] Control Server software, even across locations. The EPApr[®] Control Server offers the advantage of being able to manage the EPApr[®] 1000 devices centrally and to store all data in a central database.

Additional features when using the EPApr[®] Control Server:

- Central remote configuration of the der EPApr[®] 1000 devices across locations
- Simple import of the employee master data
- Import functions for employee data incl. access authorizations
- Large export functions e.g. for reports
- Safe and central archiving of all measured data
- Simple update function
- and many more ...

You will find all information in the text about the EPApr[®] Control Server [dplink 21904](#)

Scope of delivery:

- EPApr[®] Personnel Tester 1000
- Footwear electrode
- Power supply unit
- Operating manual
- Factory's calibration certificate





1. 7" HD color touch screen display for an intuitive operation on the console
2. Integrated Multi-RFID reader compliant to all usual standards
3. Connections
 - 1 x snap connection 10 mm
 - 2 x banana jack (other connections possible with adapter)
4. Contact plate
5. Outputs, connections and captures
 - 2 x USB ports for external HID readers for e.g. keypad, magnetic card reader, barcode scanner or WLAN via USB antenna
 - Network, LAN and Ethernet connection for connecting customer system, database server, computer, WLAN via USB antenna
 - Configurable potential-free switch outputs for signal lights, turnstiles / door release
 - Integrated T/RH sensor for temperature and humidity measurement
 - Input for calibration
 - Connection for footwear electrode

Technical data:

Voltage / power	6 W (9 V/DC) (power supply unit 100-230V/AC)
Operating conditions	+ 10 to 40° C / up to 75% relative humidity
Test time	< 2 seconds
Device: dimensions / weight	265 x 180 x 100 mm / 1 kg
Footwear electrode: dimensions / weight	500 x 350 x 8 mm / 2.6 kg

Test voltage	Selectable: 100V / 50V / 30V/DC (tolerance ±5%)	
Test of	Measuring range Upper thresholds	Measuring range Lower thresholds
Wriststrap	1 MΩ - 200 MΩ	none / 100 KΩ / 750 KΩ
Footwear worn against metal plate (value per shoe)	1 MΩ - 200 MΩ	none / 100 KΩ / 750 KΩ
Footwear measurement "in series" (hands-free)	1 MΩ - 200 MΩ	none / 100 KΩ / 750 KΩ

dpvlink 21010



- | Article | Type |
|--------------------|---|
| EPApro.1000 | EPApro® Personnel Tester 1000 table-top device
For installation on tables or pedestals <ul style="list-style-type: none"> • color touch screen display • integrated Multi-RFID reader standard type • footwear electrode |
| EPApro.1000.2W | EPApro® Personnel Tester 1000 wall-mounted device
For mounting on walls <ul style="list-style-type: none"> • color touch screen display • integrated Multi-RFID reader standard type • footwear electrode |
| EPApro.1000.2W.HID | EPApro® Personnel Tester 1000 wall-mounted device HID
For mounting on walls <ul style="list-style-type: none"> • color touch screen display • integrated Multi-RFID reader type HID Prox • footwear electrode |

EPApro® Personnel Tester 1000 accessories



dpvlink 21905



- | Article | Type |
|---------------------|---|
| EPApro.1001.ID.HF | ID card High Frequency
PU = 5 pieces, printable |
| EPApro.1001.ID.LF | ID card Low Frequency
PU = 5 pieces, printable |
| EPApro.1001.TS | Divider for footwear electrode EPApro®
for screwing |
| EPApro.1001.CU | EPApro® calibration unit 1000
including calibration certificate |
| EPApro.1001.WL1 | EPApro® WLAN Adapter
connection via USB
150 Mbit/s |
| EPApro.1001.ZPM | Test mat for EPApro®
Footwear electrode separately available |
| EPApro.1001.ZSF.SET | Pedestal set for EPApro®
consisting of:
pedestal holder for EPApro® floor mat

EPApro® ESD Personnel Tester separately available |

further accessory on request

EPApro® Control Server

The EPApro® Control Server software enables to manage the measuring data, devices and employees with the EPApro® ESD Personnel testers 1000 connected via the company network.

The data are stored and saved in compliance with GDPR. A privacy mode allows the recording and display of the measurements without names. Import/export and report functions are integrated.



EPApro® Control Server at a glance

- Networking of several EPApro® devices within your company network – also across locations
- Central, password-protected and role-based administration
- Central administration of employees and access authorizations on the server
- Simple import of the employee master data into the system e.g. Excel, CSV
- Employee administration with group function e.g. teams and departments, EPA, laboratory, etc.
- Guest function: simple creation of visitors to document the measured values
- Synchronization and storage of the data on the VM on your server
- Safe and central archiving of your measured data offering the possibility to set a date for an automatic deletion of the measurement protocols
- Backup functions allow retrieving backup files with Single Click at any time and storing them in a directory you specified
- REST API data interface (key-protected) enabling an automatic data exchange with other programs
- Report functions, i.a. for audits as PDF file
- Automatic report function by e-mail for evaluations and reports
- Installation via a Virtual Machine (VM) on your server
- Client access via browser, installation of a client software is not required
- Simple update function and maintenance of the software via the EPApro® portal

The EPApro® Control Server helps to manage the data collected by the EPApro® 1000 devices in a clear and safe way in compliance with data security. The EPApro® Control Server facilitates a central management across locations of all networked EPApro® 1000 devices. It is possible to import employee data comfortably (e.g. as CSV or Excel file) and assemble and export reports including measured data as needed.

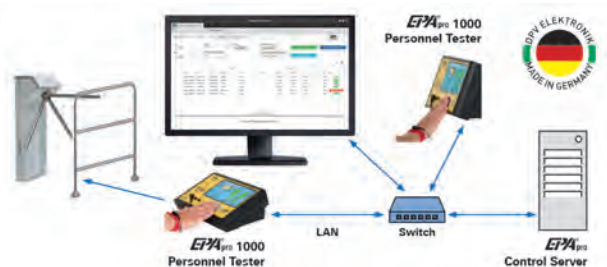

Authorization of the employees for individual devices

The authorization of the employees for the access to an EPApro® 1000 device can be restricted in the employee profile. If the EPApro® 1000 are connected to access systems, the access to individual manufacturing areas can be controlled. For an easier management and surveillance, it is possible to assign employees to a group. Groups can be structured hierarchically facilitating the mapping of employee and department structures.

Users of the EPApro® Control Server obtain the access authorization to these groups.

Network

The EPApro® 1000 devices are connected to the EPApro® Control Server via LAN. Every EPApro® 1000 device has its own IP address. The connection across locations is also possible via your company VPN.

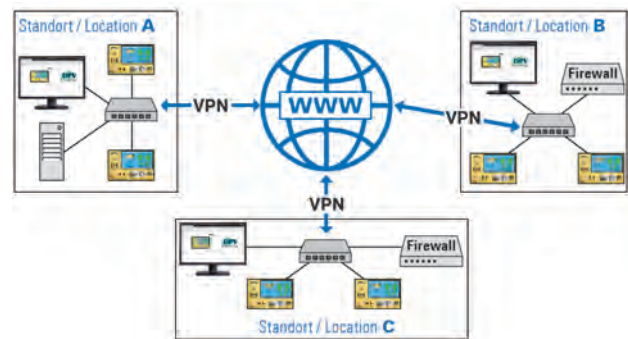

Data exchange

A REST (Representational State Transfer) API enable the secure exchange of data with other programs.



Behavior in case of failure of network or server

If the EPApro® Control Server or the network fail, there will be no restrictions for the operation of the EPApro® 1000 devices. Measurement data sets are stored in the EPApro® 1000 device and automatically transferred as soon as the EPApro® Control Server is available again. Maintenance work in the network of the server has thus no impact on the availability and functionality of the EPApro® 1000 device in the network. Even in case of a network failure, the smooth operation of the EPApro® 1000 devices is assured.

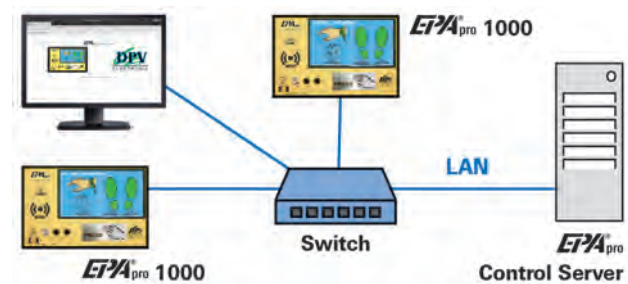

Installation of the server software

The EPApro® Control Server software is installed as a VM (Virtual Machine) on a hardware server. We provide you the VM image suitable for your virtualization system.

Licensing

A license is once necessary for the EPApro® Control Server. To connect the EPApro® Personnel Tester 1000, a separate EPApro® license key is required for each device.

dpvlink 21904

Article	Type
EPApro.1000.LI-1	EPApro® Control Server license 1 license to manage the EPApro® Control Server
EPApro.1000.LI-2	EPApro® Personnel Tester device license 1 license for device management



EPA Access control system



An access control system assures that only authorized persons are authorized to access to limited areas like an EPA protected zones or manufacturing areas.

For the ESD safety it is important that existing personal ESD protective equipment like shoes and / or wriststraps is functional.



In combination with the modern EPApro® personal grounding test system it is possible check and document the function of the personal ESD protective equipment when accessing an EPA protected zone.

The programmable potential-free switch outputs of the EPApro® ESD Personnel Tester 1000 allow activating a door opener or an access control system.



The special functions of the EPApro® ESD Personnel Tester 1000 enable to configure the access in such a way that e.g. a measurement of the personal ESD protective equipment takes place only once a day.



The integrated Multi-RFID reader for personal identification retrieves the stored access rights.

The EPApro® Control Server enables to connect the EPApro® ESD Personnel testers 1000 via the company network and to configure and manage them from a central point. The logged data are centrally stored on the server.

Further information about the EPApro® ESD Personnel Tester 1000 can be found under [dpvlink 21010](#)

Barrier system COMPACT

Very small and robust construction is suitable for high-frequency entrances. The motorized turnstile Compact has a weather-proof, powder-coated housing with integrated height-adjustable pedestal.



Properties:

- especially compact construction
- 2-arm or 3-arm version
- maintenance-free mechanism
- entrance side can be changed
- high transit flow-rate
- secure traffic separation
- noiseless operation
- height-adjustable
- durable quality
- delivered completely assembled
- suitable for outdoor use

Technical data:



- Operating voltage: 230 V / 50-60 Hz
- Power consumption: Max. 50 Wh
- Storage temperature: -40°C to +50°C
- Operating temperature: -20°C to +50°C
- Width/passage: 305 mm/577 mm
- Length: 350 mm
- Height: 1,000 - 1,365 mm
- Weight: 45 kg
- Material: steel, powder-coated CrNi steel V2A, material 1.4301
- Interfaces: potential-free contacts

Card readers can be attached to the housing by means of a reader bracket. **Optionally available with integrated personnel test station PGT 120.**

The durable quality guarantees a high transit flow-rate. With the one- or two-way operation the turnstile can be used as entrance as well as exit.

[dpvlink 20079](#)

Article	Type
6COM.2.AEB-H	Turnstile Compact 2-arm Galvanized and plastic-laminated steel
6COM.3.AEB-H	Turnstile Compact 3-arm Galvanized and plastic-laminated steel
6COM.3.AEW	Turnstile Compact 3-arm including integrated PGT 120 galvanized and plastic-coated steel



Barrier system MODUL CROSS

With the stainless steel housing the motorized turnstile as 2-arm or 3-arm version is very robust and also suitable for outdoor use.



Properties:

- compact construction
- 2-arm or 3-arm version
- maintenance-free mechanism
- entrance side can be changed
- high transit flow-rate
- secure traffic separation
- noiseless operation
- height-adjustable
- durable quality
- delivered completely assembled
- suitable for outdoor use
- easy to service due to tiltable lid



Technical data:

Operating voltage:	230 V / 50-60 Hz
Consumption:	50 Wh
Storage temperature:	-40°C to +50°C
Operating temperature:	-15°C to +40°C
Width/passage:	275 mm/550 mm
Length:	1,225 mm
Height:	1,025 mm
Weight:	70 kg
Material:	CrNi steel V2A, material 1.4301
Interfaces:	potential-free contacts, RS485, RS232

A high transit flow-rate and a maintenance-free mechanism allow for a long useful life. Card readers can be optionally integrated into the housing.

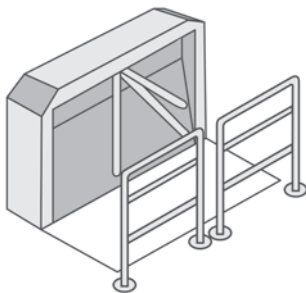

Drawing:
example setup MODUL CROSS

dpvlink 20086

Article	Type
6MCR.2.AEC	Turnstile MODUL CROSS 2-arm motorized
6MCR.3.AEC	Turnstile MODUL CROSS 3-arm motorized



Barrier system IKARUS HOLM 1000

The waist-high motorized swing gate Ikarus Holm is especially suitable for passages that have to be passed with baggage, wheelchairs or bulky goods. Due to its simple design Ikarus Holm fits well in every architecture.



Properties:

- waist-high motorized swing gate
- double entrance possible
- smooth running
- maintenance-free mechanism
- entrance side can be changed
- high transit flow-rate
- noiseless operation
- height-adjustable
- durable quality
- delivered completely assembled
- architecture-friendly transparency



Technical data:

Power supply:	24 V
Consumption:	50 Wh
Storage temperature:	-40°C to +50°C
Operating temperature:	-10°C to +50°C
Width/passage:	900 mm/950 mm
Length:	1,954 mm
Height:	1,000 mm
Weight:	35 kg
Material:	CrNi steel V2A, material 1.4301
Interfaces:	potential-free contacts



Also suitable as paired double entrances or for one-/two-way operation. We will be pleased to help you with the implementation of your requirements.

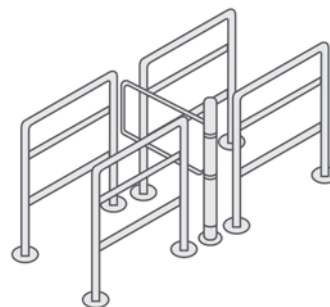

Drawing:
example setup IKARUS HOLM

dpvlink 20082

Article	Type
6IKH.1.AEC	Single swing gate IKARUS HOLM
6IKH.1.AEC.2	Double swing gate IKARUS HOLM



PGT 120 Personnel grounding tester

The personnel grounding tester PGT 120 is a wrist strap and footwear tester used for the access control of ESD protected areas.

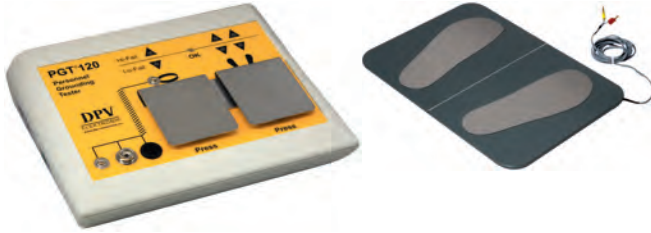

- The test result is indicated with visual and acoustic signals. An additional floating relay contact provides the possibility to activate e.g. a door opener or a turnstile for access control.
- Power is supplied via an integrated battery or a power supply unit.
- The separate measuring circuits allow the simultaneous testing of wrist strap, left and right shoe.
- Separate measurement of the contact resistance of the left and right shoe
- In combination with an access control system (e.g. turnstiles), the footwear measurement can be performed in the so-called "hands-free mode" without pressing a button
- Test voltage 30 V, 50 V or 100 volt (default setting)
- The lower limit values can be deactivated.
- Can be used as desktop and wall-mounted device (wall mounting requires an additional wall mounting plate)
- Limit values adjustable via DIP switches



dpvlink 10131

Article	Type
7100.PGT120	Personnel grounding tester PGT 120



Calibration unit for PGT 120



Calibration unit contains resistances with limit values for the on-site verification of the PGT 120 personnel grounding tester ⚠

dpvlink 10133

Article	Type
7100.PGT120.CU	Calibration unit for PGT 120 with 8 Dip switches



7100.PGT120.CU.12	Calibration unit for PGT 120 with 12 dip switches
-------------------	---

METRISO® 3000 measurement kit



METRISO® 3000 measurement kit,

consisting of the digital high resistance meter Metriso® 3000, a pluggable temperature and humidity sensor, USB interface, PC software for Windows®, 2 measuring electrode, 1 hand electrode, measuring cables, user manual (German/English), factory calibration certificate and a conductive carrying case with dissipative pink foam according to DIN EN 61340-4-1.



1. USB port
2. interface for temperature/humidity sensor and bar-code scanner
3. 2 sockets for testing the reference resistance 10 MΩ



- suitable for measuring of point-to-point resistances and bleeder resistances
- Integrated data memory allows the logging of 50,000 measured values that can be read out via an USB interface to the PC
- Logging software "ETC" facilitates the creation and recording of complete test protocols
- with pluggable sensor for measuring temperature and humidity
- The application of the bar code scanner allows an automatic identification of the measuring points before the measurement

Technical data:

Measuring voltage/ ohm range:	1mA ≤ I ≤ 1.3 mA
measuring current: high ohmic range:	direct current 10, 100 und 500 V
Measuring range: low ohmic range:	0 up to 10kOhm
high ohmic range:	1 kOhm bis 1.2 TOhm
Operation mode:	battery mode
Electrode:	2 x model 850 with conductive rubber 1 x hand electrode model 45

dpvlink 16556

Article	Type
7100.3000.MK	METRISO® 3000 - measurement kit German, complete
7100.3000.G	METRISO® 3000 measurement device (without accessories)
7100.3000.SC.D2	Barcode scanner for 2D and 1D codes



Glove garment electrode

The electrode is designed to measure the bleeder resistance of fingercots and worn gloves according to ANSI / ESD TR53-01-15



- insulating plastic frame with 4 mm banana jack
- contact electrode of stainless steel
- dimensions: 130 x 80 x 40 mm (H x W x D)
- weight: 460 g

dpvlink 19944

Article	Type
7220.15	Glove garment electrode according to ANSI/ESD TR53-01-15



Clamping electrode



- for the measurement of point-to-point resistances on ESD clothes
- contact surface of stainless steel 50 x 25 mm
- with clamping effect for a good contacting
- connection: 1 banana jack
- corresponds to IEC 61340-4-9



dpvlink 17700

Article	Type
7220.CL.49	Clamping electrode PU = 2 pieces



Backrest probe



For bleeder resistance measurements of backrests of ESD chairs with conductive contact rubber with silver particles $R < 5$ ohms.

- Total resistance per electrode $R < 100$ ohm
- Diameter 63.5 mm
- Insulated handle
- Connection 4 mm banana plug socket

dpvlink 19739

Article	Type
7220.900	Backrest probe



Hand electrode model 450



For the measurement of "system resistance person / shoes / ground" and walking test according to DIN EN 61340-4-5 

- \varnothing 25 mm, length 75 mm, weight approx. 130 g
- electropolished stainless steel

dpvlink 8491

Article	Type
7220.450	Hand electrode model 450



Measuring electrodes

Measuring electrodes for the measurement of the bleeder and surface resistances according to DIN IEC 61340-4-1, DIN EN 61340-2-3 

dpvlink 4699

Article
Type



7220.850

Measuring electrode ETS type 850

- Diameter \varnothing 63.5 mm
- Weight 2.25 kg,
- Conductive contact rubber ($R < 200$ ohm)
- Total resistance of the electrode $R < 150$ ohm
- Banana plug socket 4 mm
- Scope of delivery: 1 piece



7220.870

Measuring electrode type 870

- diameter 63.5 mm / 2.27 kg
- for the measurement of point-to-point and bleeder resistances
- conductive rubber with silver particles ($R < 100$ Ohm)
- banana plug socket under the insulated handle



7220.870.SET

Measuring electrodes 870-SET

Consisting of:

- 2x measuring electrode model 870
- conductive case
- grid pattern foam



7220.870.V.SET

Extension three-part (for electrode 870)

for the measurement on floor systems with insulated handle

EFM®51 Walking Test Kit



EFM®51 with conductive base and measuring head MK 51. By attaching the measuring head MK 51 EFM can be used for the verification measurement of the body voltage (walking test) according to IEC 61340-4-5. The measuring head MK 51 is specially calibrated to the EFM®51. The positive and negative "PEAK" value of the measured body voltage is displayed

Scope of delivery:

- EFM®51 with measuring head MK 51
- Conductive case
- Conductive base
- Measuring lead and hand electrode

dpvlink 19761

Article	Type
7100.EFM51.WT	EFM®51 Walking Test Kit



EFM®51 Verification Kit



Mobile, handy electric field meter with digital display for the measurement of electrostatic fields and charges

- By means of the measuring head MK 51 included in the verification kit it is possible to use the EFM®51 for verifying the measurement of the body voltage (walking test) according to IEC 61340-4-5
- The also included Charged Plate kit allows the measurement of the effectiveness of ionizers and their offset voltages

Scope of delivery:

- EFM®51 - CPS (Charged Plate Set)
- EFM®51 - Walking Test Kit
- factory calibration certificate
- conductive carrying case

dpvlink 21679

Article	Type
7100.EFM51.VK	EFM®51 Verification Kit



WT 5000.A Walking test kit

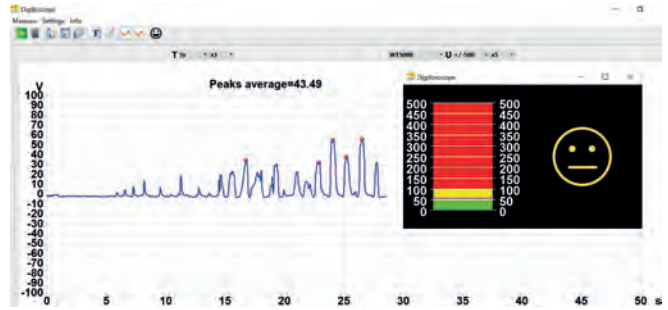
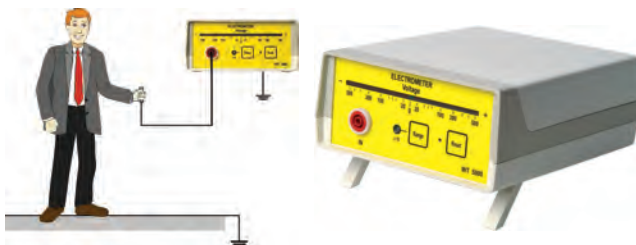

The walking test kit is used mainly to measure the body voltage and their graphical presentation.

The A/D converter can present the measurement data of body voltage "online" on the PC or laptop and as a graphic. ⚠️

Technical data:

Electrometer WT 5000:

- Measuring range: ± 5,000 Volts
- Measurement accuracy: 5% of the measured value
- Input resistance: > 10¹⁴ ohm
- Input capacity: < 5 pF
- Display: logarithmic LED display ± 500 V switchable to ± 5000 V, peak hold function
- Output: Analog ± 5V DC for each area
- Operating mode: Batteries (charger included)

A/D converter:

- Input resistance: 1 MOhm
- Interface: USB 2.0 / USB 1.1 (08.2008)
- Input voltage: ± 5 Volts DC
- Resolution: 12 Bit
- Max. sampling frequency: 15 kHz
- Power supply: via USB interface
- Measuring software: for WINDOWS®

Scope of delivery:

- Electrometer WT5000
- A/D converter
- measuring software Digilloscope (CD-ROM)
- rechargeable batteries
- Hand electrode
- measuring cables and connectors
- Conductive carrying case
- User manual
- Factory calibration certificate

dpvlink 4695

Article	Type
7100.WT5000.B	WT 5000 walking test kit incl. A/D converter with USB interface



EPAclean® Cleaning supplies

Quick and simple cleaning for conductive surfaces in ESD areas. Clean reliably your work place and table coverings as well as floorings and other surfaces. The high-quality ESD cleaner of the new EPAclean® cleaning series professional is ready-to-use and available as spray bottle and refill canister. When used for maintenance cleaning the EPAclean® concentrate ESD Floor Cleaner professional is very economical. If a basic cleaning is necessary, the ESD Basic cleaner professional concentrate produces excellent results.



ESD Cleaner professional



EPAclean® ESD Cleaner professional for the quick and easy cleaning of ESD surfaces



- ready-to-use cleaner
- binds loose dust and fine dirt in a hygienic way
- cleans without streaking and does not build up layers
- spray nozzle allows damp-wiping due to a controlled and well-measured dispersion of the cleaner
- prevents overdosage and swelling effects caused by excessive moisture
- surface dries completely and is usable within a very short period of time

dpvlink 22449

Article	Type
2920.2001	EPAclean® ESD Cleaner Professional 1l aerosol
2920.2005	EPAclean® ESD Cleaner Professional 5 liter canister
2920.2002	EPAclean® ESD Cleaner professional 250 ml bottle



ESD Floor Cleaner professional



EPAclean® ESD Floor Cleaner professional suitable for the maintenance cleaning of all ESD PVC floorings and epoxy



- excellent dirt-binding characteristics, even with greasy residues
- no leaching of the surface
- no formation of grey haze
- cleaning without stripes
- concentrate
- dilution ratio 1:200
- Can be used in automatic scrubber (mixing ratio 1:400)

dpvlink 22452

Article	Type
2920.2010.K	EPAclean® ESD Floor Cleaner Professional 10 liter canister



ESD Basic Cleaner professional



EPAclean® ESD Basic Cleaner professional for the gentle and effective basic cleaning of ESD floors



- for the removal of waxes, wash products, care coatings as well as adhesive residues and building dirt during the final cleaning after construction work with a given PU treatment at the factory
- high dissolving power and of gentle low alkalinity
- all-purpose basic cleaner for all elastic floorings
- concentrate
- dilution ratio 1:10

dpvlink 22454

Article	Type
2920.2050.K	EPAclean® ESD Basic cleaner Professional 5l canister



Subject index

A			
ABEBA Professional footwear	19-33		
Access control	153-158		
Access control system	153-155		
ALBATROS professional footwear	80-83		
Analog-to-digital converter	160		
ATLAS Professional footwear	64-70		
B			
BAAK Professional footwear	97-101		
Backrest electrode	159		
Barcode scanner	158		
Barrier system	156		
BATA Professional footwear	93-96		
BIRKENSTOCK Professional footwear	17-18		
Bleeder resistance measurement	158		
Bouffant cap	136		
Business / Manager shoe	31, 40, 42-43, 63, 69-70, 74		
C			
Calibration units ---> measuring and testing devices	158		
Canmat	105		
Cap, reusable	118		
Care product shoes	103-104		
Chair - Armrests	149-151		
Chair - backrest adjustable	149-151		
Chair - base aluminium	149-151		
Chair - ESD castors	150		
Chair - ESD glides	150		
Chair - gas spring (extended)	150		
Chair cover - fabric	149-151		
Chair cover - synthetic leather	149-151		
Chair with backrest	149-151		
Chair with castors	149-151		
Chair with glides	150		
Chairs	159		
Clamping electrode	159		
Cleaning	161		
Cleaning - shoes	108		
Cleaning, antistatic	161		
Cleanroom	131-133		
Cleaning agents / products	161		
Clogs	13-16, 19-23, 26, 28, 32, 42, 54		
Clogs ---> Safety clogs	42, 68		
Clothes	108-136		
Clothes with collar	115-118, 120-121, 125-126, 128-129, 131, 134		
Clothes with pockets	115-118, 121, 128-129, 131, 134		
Clothes, long sleeves	115-118, 121, 125, 128, 131		
Clothes, short sleeves	116-117, 119-121, 124-128		
Coat design - 3/4 long, short sleeves	117		
Coat design - short, short sleeves	116		
Coat version - 3/4 long, long sleeves	115, 117-118, 131		
Coat version - short, long sleeves	116		
Compact	156		
Contact heat resistant	143		
Contact stripes	104-107		
Contact strips	104-107		
D			
Dispenser, for overshoes	104		
Disposable clothes	133-136		
Disposable cuffs	135		
Disposable finger cots	146		
Disposable gloves	146		
Disposable heel strap	104-107		
Disposable heel straps	104-107		
Disposable hood	135		
Disposable overshoes	104-107		
Disposable skirt	135		
Documentation / Archiving	158		
DPV swivel chairs	147-152		
DPV- komfort	13-16, 149		
E			
Electric field meter	160		
Electrode	159		
Electrode, backrest	159		
Electrode, manual	159-160		
ELTEN professional footwear	54-63		
EPA	105		
EPA Electrostatic Protected Area	153-155		
EPACHair	147-152		
EPAClean	161		
EPAGlove	137-141		
EPApro 1000	153-157		
EPApro Control Server	153-155		
EPAwear	109-115, 126-127		
ESD clothes	128, 130		
ESD gloves	137-146		
ESD shoes	13-100		
ESD socks	102-103		
ESD Workwear	108-136		
F			
Finger cots	146		
Foil tacky mats	108		
Footbeds	33, 40, 46, 53, 63, 70, 101		
FTG professional footwear	90-92		
G			
Gaiter	32		
Gloves - CARBON	138-139		
Gloves - COOPER	139-140		
Gloves - LEO	137-138		
Gloves - Palms coated	137-139, 142-145		
Gloves - polyester	140-141		
Gloves - TEGERA	141-144, 146		
Gloves - textile	139-140		
Gloves EPAGlove	137-141		
H			
Half-finger gloves	146		
I			
ID card cover	136		
Ikarus Holm	157		
Impregnation spray	104		
Industrial sole cleaner	108		
J			
Jackets, winder	123, 129		
JALAS Professional footwear	34-40		
L			
Lanyards	136		
LEMAITRE professional footwear	84-86		
LEMAITRE Safety shoes	84-86		
Loafer	24, 26, 32, 40		
Loafer ---> Safety loafer	25, 29-30		
LUPOS professional footwear	47-48		
M			
Manual electrode	159-160		
Mask	136		
Measuring case	158		
Meters and testers	153-157		
Metriso 3000	158		
Modul Cross	157		
O			
Orthopedic insoles	101		
Overshoes	104-107		
Overshoes, reusable	104-106		
P			
Permanent heel straps	104-107		
Permanent sole grounders	107		
Permanent toe straps	104-107		
Personnel test station	153-155		
PGT 120 Personal test station	158		
Point-to-point resistance measurement	158		
Polo shirts	120-121, 124-127		
PremiumSmooth	126-127		
Professional footwear	13-100		
Professional footwear - ABEBA	19-33		
Professional footwear - ATLAS	64-70		
Professional footwear - BAAK	97-101		
Professional footwear - BATA	93-96		
Professional footwear - BIRKENSTOCK	17-18		
Professional footwear - DPV komfort	13-16		
Professional footwear - ELTEN	54-63		
Professional footwear - JALAS	34-40		
Professional footwear - SIEVI	41-46		
Professional footwear - STEITZ SECURA	87-89		
Professional footwear FTG	90-92		
Professional footwear LUPOS	47-48		
PU foam	137-139, 142-145		
PUMA professional footwear	76-79		
R			
Reflective vest	129		
S			
Safety boots	13-100		
Safety shoes	18, 24-31, 34-40, 42-75, 77-79, 81-82, 84-101		
Safety shoes LEMAITRE	84-86		
Safety shoes U-POWER	49-53		
Safety shoes uvex	71-75		
Safety sneaker	69		
Sandals	13-15, 17-18, 23, 41-42, 85, 97		
Shoe care product	103-104		
Shoe care products	103-104		
Shoe tester	158		
SIEVI professional footwear	41-46		
Slippers	13-18, 23, 41-42		
Socks ESD	102-103		
Softshell jacket	129		
Sole cleaning	108		
Special footwear	32		
STEITZ SECURA Professional workwear	87-89		
Stool	151-152		
Suitcase	160		
Sweat jacket	121-125		
Sweatshirts	121-125		
Swing gate	156-157		
Swivel chairs / swivel stool	149-152		
Swivel chairs series CLASSIC	149-151		
Swivel stool	151-152		
T			
T-shirt	119, 124-127		
Tacky mats / foils	108		
Tank top	119		
Testing device	158		
Thermo-Cool	124-125		
Toe strap, women	104-107		
Trousers	130		
Turnstile	153-157		
Turnstiles	153-157		
Tyvek	134-135		
W			
Walking - Test kit	160		
Wall bracket	158		
Wedge heel	13-14		
Winter clothes	128, 130		
Work coat BlueLine plus	113		
Work coat GreyLine plus	111-112		
Work coat WhiteLine plus	109-111		
Work coats	109-118		
Work shoes	13-100		
Workstation swivel chairs	147-152		
Workwear	108-136		

EPA – ESD protected area

Requirements according to DIN EN 61340-5-1

ESD control element	Product qualification ^{a)}		Compliance verification ^{b)}	
	Test procedure	Limits ^{c)}	Based on testing procedures	Limits ^{c)}
Work surfaces, storage shelves and transport trolleys ^{g)}	IEC 61340-2-3	$R_{gp} < 1 \times 10^9 \Omega$ $R_{p-p} < 1 \times 10^9 \Omega$	IEC 61340-2-3	$R_g < 1 \times 10^9 \Omega$
Wrist strap connection point				$R_g < 5 \times 10^6 \Omega$
Flooring	IEC 61340-4-1 ^{d) e)}	$R_{gp} < 1 \times 10^9 \Omega$	IEC 61340-4-1	$R_g < 5 \times 10^9 \Omega$
Ionization	IEC 61340-4-7	Decay (1000 V to 100 V and -1000 V to -100 V) < 20 s Offset voltage < +/- 35 V	IEC 61340-4-7	Decay (1000 V to 100 V and -1000 V to -100 V) < 20 s Offset voltage < +/- 35 V
Seating	IEC 61340-2-3 (measurement of resistance to groundable point)	$R_{gp} < 1 \times 10^9 \Omega$	IEC 61340-4-9	$R_{p-p} < 1 \times 10^{11} \Omega$
EPA-clothing	IEC 61340-4-9	$R_{p-p} < 1 \times 10^{11} \Omega$	IEC 61340-4-9	$R_{p-p} < 1 \times 10^{11} \Omega$
Groundable EPA clothing	IEC 61340-4-9	$R_{gp} < 1 \times 10^9 \Omega$	IEC 61340-4-9	$R_{gp} < 1 \times 10^9 \Omega$

a) For product qualification, the environmental conditions for the test should be 12 (± 3) % relative humidity and 23 (± 2) °C. Unless specified in the referenced IEC standards, the minimum ambient temperature conditioning time for product qualification should be 48 h.

b) The test methods in the compliance verification column refer only to the basic test method. The test methods are not expected to be fully followed.

c) Symbols used in this table: R_{p-p} refers to point-to-point resistance, R_g corresponds to resistance to ground and R_{gp} refers to resistance to groundable point.

d) The maximum admissible test voltage for the measurement of ESD floor coverings to be used for an ESD program that complies with this standard is 100 V.

e) If a flooring is used to ground the personnel handling ESDS, reference is made to the system requirements in table 2.

f) In situations where damage from the Charged Device Model (CDM) must be considered, a lower threshold of the point-to-point resistance R_{p-p} of $1 \times 10^4 \Omega$ is recommended.

g) Working surfaces are defined as any surface on which an ESD-sensitive element is placed.

Personnel grounding

Requirements according to DIN EN 61340-5-1

ESD control element	Product qualification		Compliance verification	
	Test procedure	Limits ^{b)}	Based on testing procedures	Limits ^{b)}
Wrist straps (straps and grounding cable)	IEC 61340-4-6	$R < 5 \times 10^6 \Omega$ or user-defined threshold	See wrist strap system	
Resistance of the wrist strap	IEC 61340-4-6	Inside: $\leq 1 \times 10^8 \Omega$	Not applicable	
		Outside: $\leq 1 \times 10^7 \Omega$	Not applicable	
Wrist strap system ^{a)}	Not applicable		IEC 61340-4-6 Testing the electrical connection of the wrist strap	$R < 3,5 \times 10^7 \Omega$
Footwear	IEC 61340-4-3 ^{c)}	$R \leq 1 \times 10^8 \Omega$	See system person / footwear	
System person / footwear / floor	IEC 61340-4-5	$R_g < 1 \times 10^9 \Omega$ ^{e)} and absolute value of body voltage $< 100 \text{ V}$ (average of the 5 highest peaks)	IEC 61340-4-5	$R_g < 1,0 \times 10^9 \Omega$ ^{d), f)}
System person / footwear	Not applicable		–	$R_{gp} < 1,0 \times 10^8 \Omega$

a) In situations where EPA clothing (according to IEC 61340-4-9) is used as part of the wrist strap grounding path, the resistance of the complete system should be including person, protective clothing and grounding cable should be $< 3.5 \times 10^7 \Omega$.

b) Symbols used in this table: R_g corresponds to resistance to ground and R_{gp} refers to resistance to groundable point.

c) For the product qualification of footwear according to IEC 61340-4-3, the environmental conditions for the test should be $12 (\pm 3) \%$ relative humidity and $23 (\pm 2) \text{ }^\circ\text{C}$.

d) A periodic test of the generated body voltage should be performed to verify that the voltage is less than 100 V.

e) The threshold of the resistance applies to the successive measurement of a single foot at a time, not both feet at the same time.

f) The required threshold of $< 1.0 \times 10^9 \Omega$ is the highest allowable value. The user should set an upper limit based on the resistance values measured for the product qualification of the footwear and floor system which ensure a maximum generated body voltage of 100 V, and use these resistance values for the verification of compliance.

Marking of safety shoes (Based on the current standard EN ISO 20345:2022)

Symbol	Safety class	I, II	I	I	I	I	I	I	I	I
		SB	S1	S1P	S1PL	S1PS	S2	S3	S3L	S3S
	Protective toe cap	●	●	●	●	●	●	●	●	●
SR	Slip resistance prescribed (similar to SRA, SRB or SRC)	●	●	●	●	●	●	●	●	●
	Closed seat area (complete closed heel)		●	●	●	●	●	●	●	●
A	Electrical resistance (0.1 – 1000 Ω)		●	●	●	●	●	●	●	●
E	Energy absorption under the heel		●	●	●	●	●	●	●	●
P	Steel penetration protection			●				●		
PL	Non-metallic penetration protection				●				●	
PS	Non-metallic penetration protection					●				●
WPA	Water penetration and absorption						●	●	●	●
	Slip-resistant sole							●	●	●

Marking of professional shoes (Based on the current standard EN ISO 20347:2022)

Symbol	Safety class	OB	O1	O2	O3
Shoes in assembled condition					
	Toe protection (200 joules)				
SR	Slip resistance (SRA, SRB or SRC)	●	●	●	●
P	Penetration protection	○	○		●
A	Antistatic shoes	●	●	●	●
E	Energy absorption in the heel area	●	●	●	●
HI	Thermal insulation of the sole complex	○	○	○	○
CI	Cold insulation of the sole complex	○	○	○	○
Shoe upper material					
WRU	Water penetration and water absorption	○	○	○	○
Outsole					
HRO	Behavior towards contact heat	○	○	○	○
FO	Fuel resistance	○	○	○	○

- Fulfills prescribed requirements
- Requirement may be fulfilled, but is not mandatory

General terms and conditions of sale, delivery and payment (excerpt)

DPV Elektronik-Service GmbH exclusively delivers for the commercial sector. A sale to private individuals is not possible.

Flat-rate shipping costs per order: (the flat-rate shipping costs are only valid for deliveries sent as standard package.)

Germany

5.90 € shipping fee,
no minimum order value

Belgium, Denmark, France, Luxembourg, Netherlands, Austria, Poland, Czech Republic and Hungary:

10.00 € shipping fee,
50.00 € minimum order value

Finland, Great Britain, Ireland, Italy, Latvia, Norway, Portugal, Romania, Sweden and Spain:

15.00 € shipping fee,
50.00 € minimum order value

For other countries and outside the EU please contact us.

Volume-dependent deliveries, deliveries by forwarder and dangerous goods are excluded.

Delivery: unpaid ex warehouse including packaging Delivery outside the EU only on request.

Conditions

For the complete terms and conditions refer to

www.dpv-elektronik.de/agb

GDPR

Current information about the General Data Protection Regulation (GDPR) is available under

www.dpv-elektronik.de/dsgvo

Prices

Your price list can be found in your personal account in our online shop. After registration via www.dpv-elektronik.de we shortly activate your personal access.

Legal notice

DPV Elektronik-Service GmbH

Workwear catalog

Version: DPV EN 2024

All prices are available on www.dpv-elektronik.de

All technical data and prices were correct at the time of printing.

This catalog was created by a DTP system and with utmost care.

We reserve the right to errors, price changes and technical modifications.

Any reproduction from our catalog requires our approval.

Copyright © 2024 by DPV Elektronik-Service GmbH, 75031 Eppingen, Germany



Your System Supplier for Electronics Manufacturing

- ESD Management
- ESD Footwear
- ESD Clothes
- Cleanroom
- ESD Protection
- Measurement and Tests
- ESD Chairs
- ESD Workplace Systems
- ESD Packaging
- ESD Storage and Transport
- Tools
- PCB Processing
- Component Processing
- Mounting Accessories
- Dispensing Equipment
- Workstation Lighting
- Optical Inspection Systems
- Cleaning
- Chemistry
- Soldering Technology

DPV Elektronik-Service GmbH
Herrengrundstr. 1
75031 Eppingen, Germany

Phone: +49 (0)7262 9163-0
E-Mail: sales@dpv-elektronik.de
Internet: www.dpv-elektronik.de

Your Contact:

EUROPE | INTERNATIONAL

DPV Elektronik-Service GmbH
Phone: +49 (0)7262 9163-200
E-Mail: export@dpv-elektronik.de

SWITZERLAND | LIECHTENSTEIN

Compumet AG
Theodorshofweg 22
4310 Rheinfelden, Switzerland
Phone: +41 (0)61 836 10 50
E-Mail: info@compumet.ch
Internet: www.compumet.ch



Visit us on LinkedIn
[linkedin.com/company/dpv-elektronik](https://www.linkedin.com/company/dpv-elektronik)

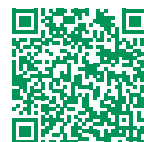

Explore our
product range online:
www.dpv-elektronik.de